



## **Table of contents**

### **for machine: IR 29 No. 0150 - 0178**

<b>1 - Frame</b>	7
<b>2 - Forward feed</b>	12
13 - Forward feed	15
<b>3 - Hood</b>	21
2 - Protective guard discharge	24
<b>4 - Needle beam</b>	27
1 - Block	32
8 - Shaft	35
2 - Block	36
25 - Distributor unit	38
3 - Bushing	41
27 - Plate	43
<b>5 - Cover</b>	44
<b>9 - Drive</b>	46
500 - Cable motor pump	49
<b>10 - Drive</b>	49
<b>11 - Softer</b>	54
<b>12 - Swivel</b>	56
<b>13 - Housing</b>	58
<b>14 - Arm</b>	61
500 - Cable pump drive	64
<b>15 - Conveyor belt</b>	65
<b>16 - Pump</b>	68
<b>17 - Lid</b>	72
4 - Switch	75
<b>18 - Mechanical components</b>	77
<b>500 - Switch box</b>	79
500 - Components	83
16 - Multi-wire cable set	86
<b>501 - Cable set</b>	86
500 - Cable supply	88
501 - Cable supply	89
503 - Cable conveyer belt / beam dri	90
505 - Cable motor belt feed adjustm.	91
506 - Bracket with cable	92
508 - Bracket with cable	93
509 - Cable switch S4	94
510 - Proximity switch B2 with cable	95
511 - Proximity switch B3 with cable	96
512 - Cable pressure transmitter	97
513 - Cable digital outputs	98
514 - Cable analog outputs	99

515 - Cable power supply display	100
516 - Cable digital inputs	101
517 - Cable analog inputs	102
518 - Cable expansion card	103
519 - Ground wire	104
520 - Ground wire	105
521 - Ground wire	106
<b>502 - Power supply</b>	<b>107</b>
<b>503 - Additional materials</b>	<b>109</b>
501 - dSys Mini IPC	111
<b>600 - Suppressor limit (optional)</b>	<b>112</b>

IR 29 No. 0150 - 0178

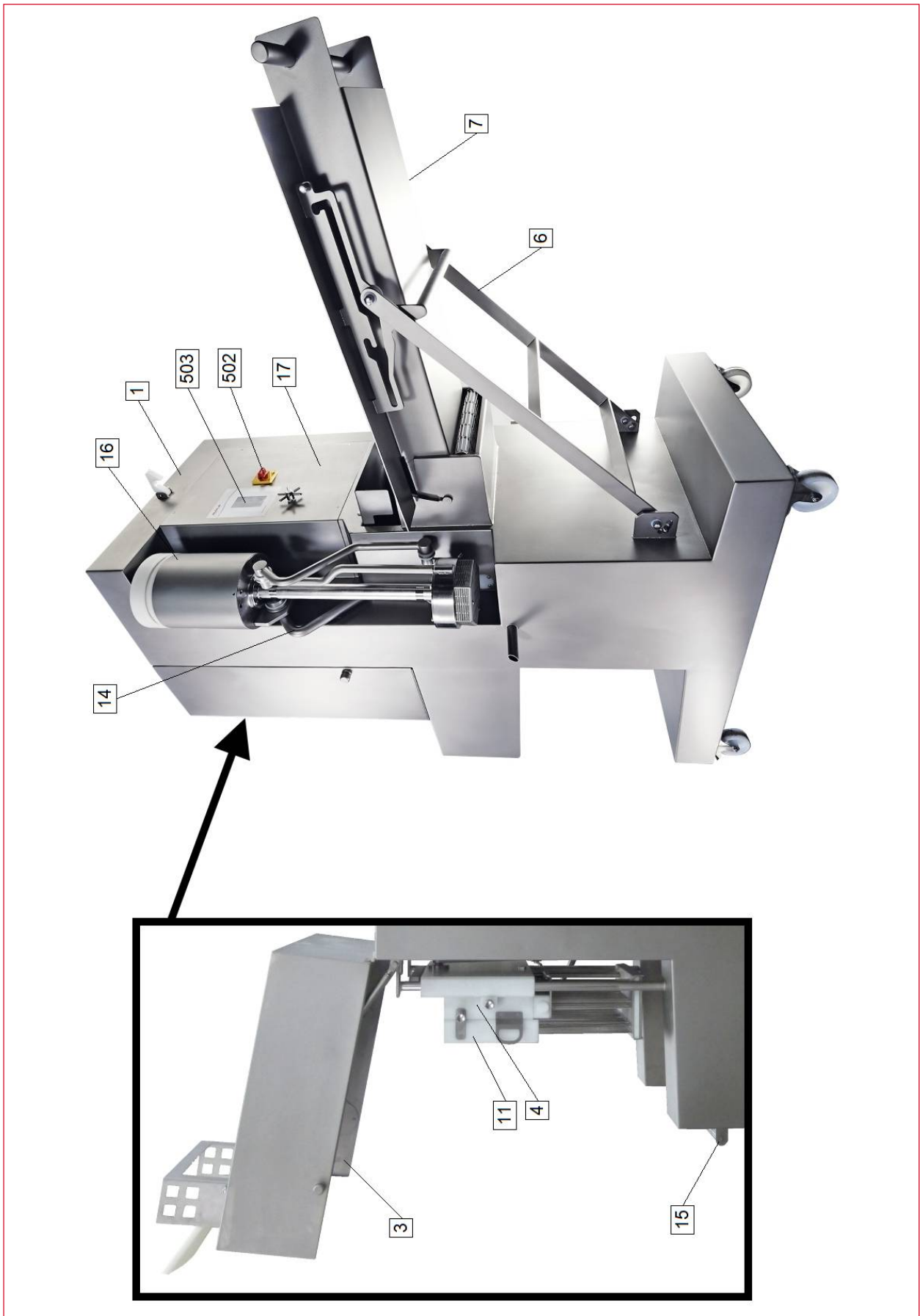

## IR 29 No. 0150 - 0178











		<i>Position No.</i>	<i>Part No.</i>	<i>Designation</i>	<i>Quantity</i>	
		1	113887	Frame IR 29	1 Stk	
		2	116672	Forward feed IR 29	1 Stk	
		3	113831	Hood IR 29	1 Stk	
		4	115350	Needle beam IR 29	1 Stk	
		5	113899	Cover IR 29	1 Stk	
		6	113901	Housing IR 29	1 Stk	
		7	113904	Table IR 29	1 Stk	
		8	113915	Filter IR 29	1 Stk	
		9	113947	Drive IR 29	1 Stk	
		10	113986	Drive IR 29 / IR 17 Turbo	1 Stk	
		11	113958	Softer IR 29	1 Stk	

		<i>Position No.</i>	<i>Part No.</i>	<i>Designation</i>	<i>Quantity</i>	
		12	113991	Swivel IR 29 / IR 17 / IR 59	1 Stk	
		13	114003	Housing IR 29	1 Stk	
		14	114555	Arm IR 29	1 Stk	
		15	113821	Conveyor belt IR 29	1 Stk	
		16	114009	Pump IR 29	1 Stk	
		17	114014	Lid IR 29	1 Stk	
		18	114072	Mechanical components IR 29	1 Stk	
		500	113649	Switch box IR 29 / IR 17 Turbo	1 Stk	
		501	113621	Cable set IR 29 / IR 17 Turbo	1 Stk	
		502	113961	Power supply IR 29	1 Stk	
		503	113957	Additional materials IR 29 / IR 17 Turbo	1 Stk	
		600	115546	Suppressor limit (optional) IR 29 (Needle beam 115350)	1 Stk	

## 1 - Frame - 113887









## 1 - Frame - 113887

		<i>Position No.</i>	<i>Part No.</i>	<i>Designation</i>	<i>Quantity</i>	
		4	113879	Base plate 996 x 663 x 1	1 Stk	
		5	113451	Slide bushing JSM-0810-06	2 Stk	
		6	F27629	Slide bushing GSM-3034-20	1 Stk	
		7	113882	Bracket IR 29	1 Stk	
		8	F26986	Countersunk bolt DIN7991 M 8 x 16	4 Stk	
		9	113670	Bracket 90 x 40 x 20	1 Stk	
		10	113885	Bolt d 8 x 48,5	1 Stk	
		11	F20414	Guide roller LEX-PO 100	2 Stk	
		12	F27793	Fixed roller BX-PO 100G	2 Stk	
		13	113477	Slide bushing GSM 1416-08	2 Stk	
		14	108987	Flange d 100 x 15	1 Stk	



		<i>Position No.</i>	<i>Part No.</i>	<i>Designation</i>	<i>Quantity</i>	
		15	F28057	Radial shaft seal d 50 x d 65 x 8	1 Stk	
		16	113880	Frame 302 x 210 x 4	1 Stk	
		17	F245269	Connector G 1/2" x 30 x 22 M 28 x 15	1 Stk	
		18	113695	Bolt d 16 x 24	1 Stk	
		19	F21035	Disc Ø 6,5 x Ø 20 x 2	17 Stk	
		20	F24031	Spring lock washer DIN127 B 6	9 Stk	
		21	F20203	Hexagonal nut DIN934 M 6	2 Stk	
		22	F20258	Washer DIN125 A 6,4	5 Stk	
		23	F20810	Cap nut DIN917 M 6	2 Stk	
		24	F20598	Countersunk bolt DIN7991 M 5 x 12	3 Stk	
		25	F25668	Hexagonal bolt DIN933 M10 x 50	2 Stk	
		26	F20147	Hexagonal nut DIN934 M 10	4 Stk	

		<i>Position No.</i>	<i>Part No.</i>	<i>Designation</i>	<i>Quantity</i>	
	27	F22888	Washer DIN125 A 8,4	16 Stk		
	28	F21260	Spring lock washer DIN128 A 8	16 Stk		
	29	F21281	Hexagonal bolt DIN933 M 8 x 16	16 Stk		
	30	F20260	Spring lock washer DIN127 B 5	16 Stk		
	31	F26993	Hexagonal bolt DIN933 M 5 x 10	16 Stk		
	32	113729	Bolt d 27 x 33	2 Stk		
	33	115376	Stop IR 29	1 Stk		
	34	113384	Countersunk bolt DIN7991 M 10 x 16	4 Stk		
	35	F250798	Hexagonal nut DIN985 M 6	8 Stk		
	36	F28732	Lock washer DIN6797-A ø 6,4	1 Stk		
	37	107046	Bolt d 15 x 48	1 Stk		
	38	F20259	Hexagonal nut DIN934 M 8	1 Stk		

		<i>Position No.</i>	<i>Part No.</i>	<i>Designation</i>	<i>Quantity</i>	
		39	F20640	Threaded pin DIN916 m 5 x 8	1 Stk	
		40	F252429	Prohibition sign Prohibited industrial trucks	2 Stk	
		41	115374	Stop IR 29	1 Stk	

## 2 - Forward feed - 116672

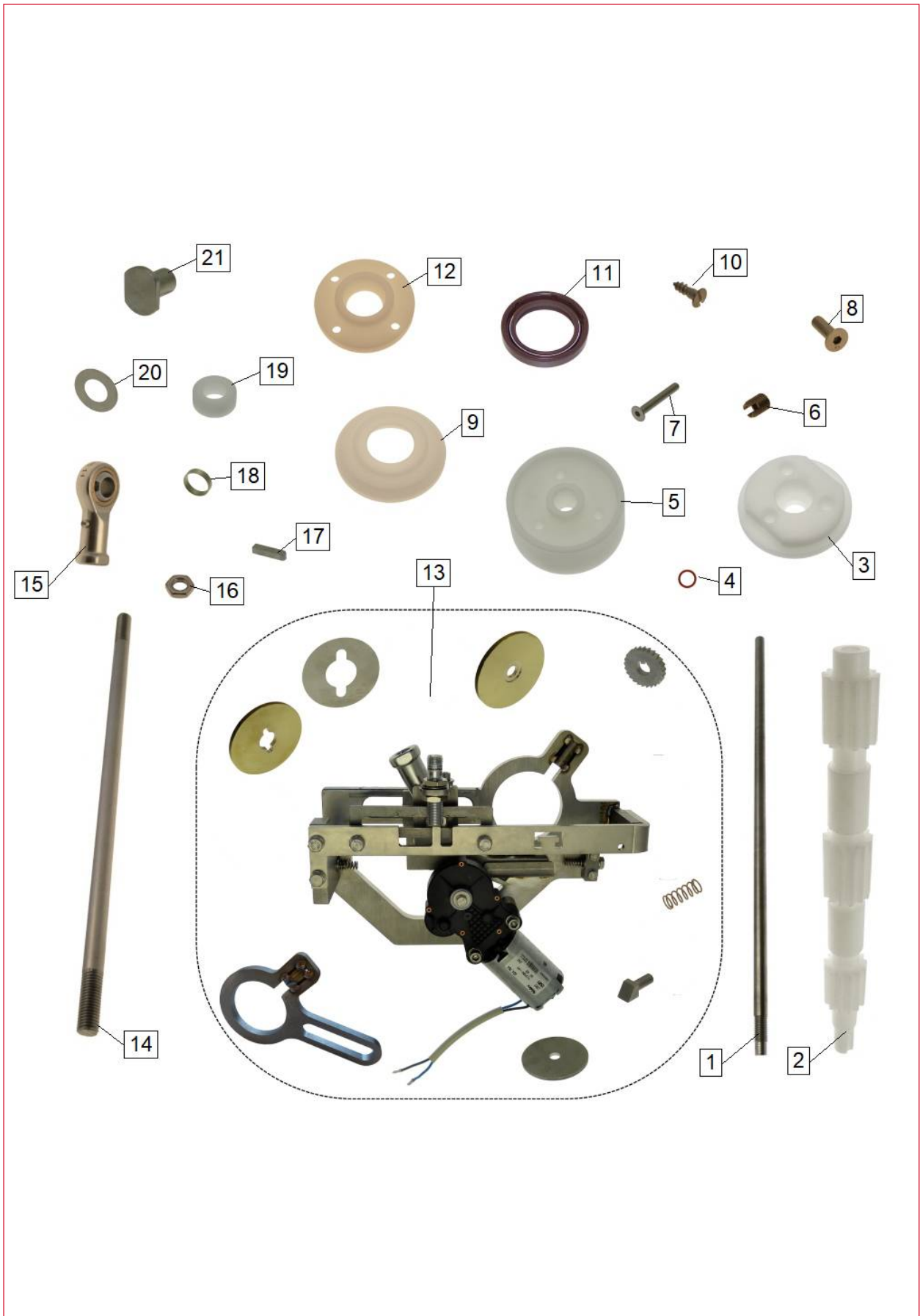

## 2 - Forward feed - 116672

		<i>Position No.</i>	<i>Part No.</i>	<i>Designation</i>	<i>Quantity</i>	
		1	113921	Shaft d 12 x 464	1 Stk	
		2	113922	Shaft d 40 x 398,5	1 Stk	
		3	113919	Flange d 60 x 19,5	1 Stk	
		4	113849	O-ring d 12 x 2	1 Stk	
		5	113920	Flange d 60 x 28	1 Stk	
		6	F255839	Thread insert M5 - d 10 x 12	3 Stk	
		7	114115	Countersunk bolt DIN7991 M 5 x 35	3 Stk	
		8	F20207	Countersunk bolt DIN7991 M 8 x 25	1 Stk	
		9	108960	Flange d 60 x 11,5	1 Stk	
		10	109560	Countersunk head wood screw d 5 x 16	4 Stk	
		11	F23692	Radial shaft seal Ø 25 x Ø 35 x 6	1 Stk	

		<i>Position No.</i>	<i>Part No.</i>	<i>Designation</i>	<i>Quantity</i>	
		12	108961	Flange d 60 x 13,7	1 Stk	
		13	116671	Forward feed IR 29	1 Stk	
		14	106900	Shaft d 14 x 410	1 Stk	
		15	F20215	Rod End GIRS 14	1 Stk	
		16	F26133	Hexagonal nut DIN439 M 14	2 Stk	
		17	116697	Adjusting spring AB 6 x 6 x 28	1 Stk	
		18	116656	Ring d 20,2 x d 22,7 x 6	1 Stk	
		19	116535	Ring d 16,2 x 30 x 12	1 Stk	
		20	116536	Ring d 16,2 x 30 x 0,5	2 Stk	
		21	116537	Bolt d 30 x 26	1 Stk	

## 13 - Forward feed - 116671

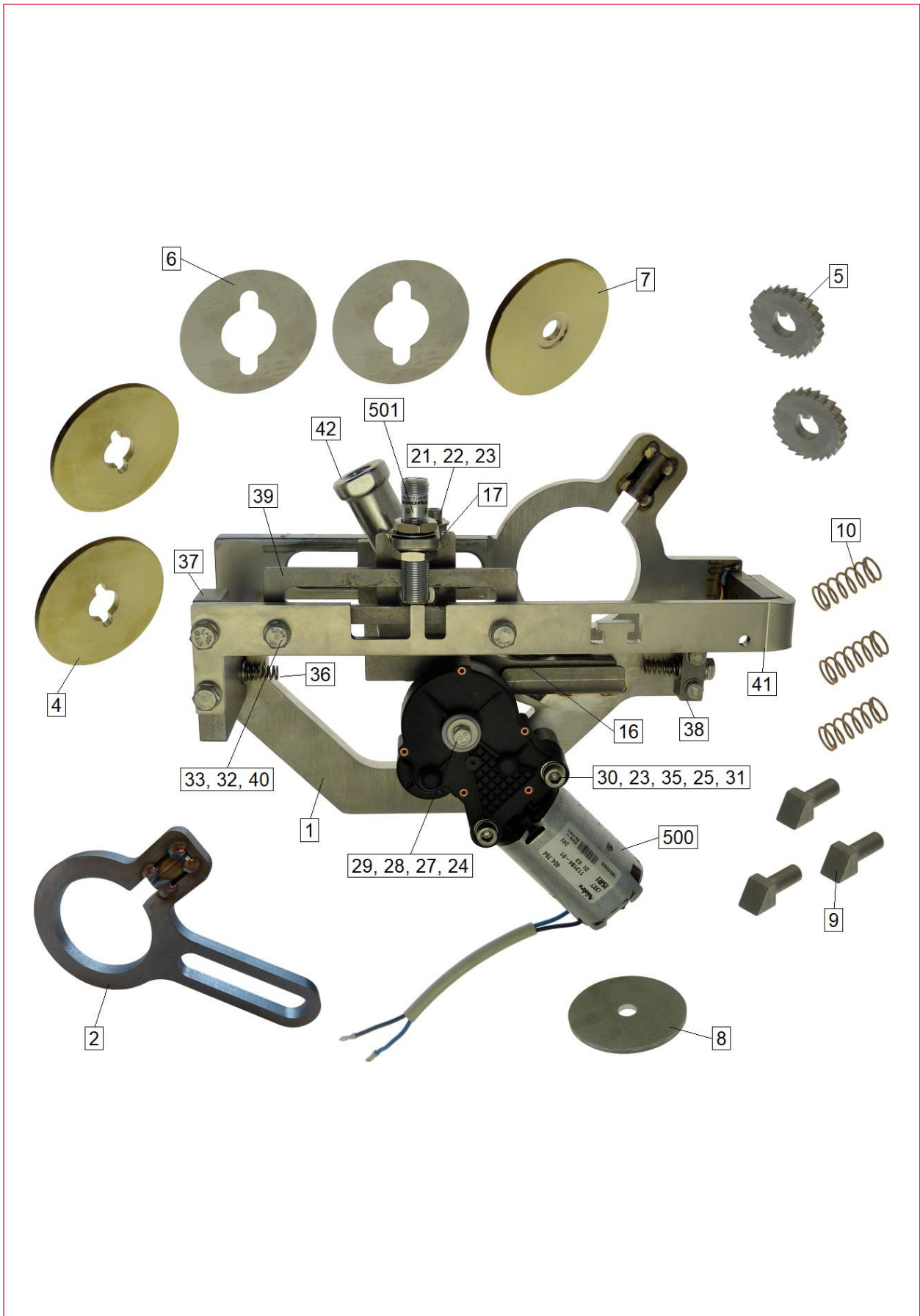

## 13 - Forward feed - 116671



		<i>Position No.</i>	<i>Part No.</i>	<i>Designation</i>	<i>Quantity</i>	
		1	116643	Forward feed IR 29 / IR 59	1 Stk	
		2	116644	Housing IR 29 / IR 59	1 Stk	
		3	115919	Bolt d 25 x 76,5	1 Stk	
		4	116657	Disc d 20,1 x d 85 x 5	2 Stk	
		5	116653	Sprocket wheel d 60 x 10	2 Stk	
		6	116534	Disc d 20,1 x d 50 x 0,3	2 Stk	
		7	115918	Compensating disc d 12,5 x d 85 x 5	1 Stk	
		8	115924	Compensating disc d 12,2 x d 75 x 4	1 Stk	
		9	115917	Bolt 9,9 x 9,9 x 26	3 Stk	
		10	F20250	Pressure spring d 0,8 x De8,8 x 21,5	3 Stk	
		11	F20179	Hexagonal nut DIN439 m 12	2 Stk	



		<i>Position No.</i>	<i>Part No.</i>	<i>Designation</i>	<i>Quantity</i>	
		12	115985	Disc d 16,2 x d 25 x 2	1 Stk	
		13	115989	Ring d 14,2 x d 25 x 8	1 Stk	
		14	113726	Disc d 14,2 x d 22 x 2	1 Stk	
		15	F20047	Hexagonal nut DIN439 M 10	2 Stk	
		16	116645	Gear rack 124 x 71 x 8	1 Stk	
		17	115990	Bracket 70 x 68 x 33,5 x 4	1 Stk	
		18	116648	Housing 30 x 22 x 4	1 Stk	
		19	116646	Housing 60 x 20 x 8	1 Stk	
		20	115984	Housing 30 x 24 x 8	1 Stk	
		21	F25848	Cylinder head screw DIN912 M 5 x 16	2 Stk	
		22	104957	Disc DIN 9021 A2 5,3	2 Stk	
		23	F20260	Spring lock washer DIN127 B 5	10 Stk	

		<i>Position No.</i>	<i>Part No.</i>	<i>Designation</i>	<i>Quantity</i>	
	24	115988	Sprocket wheel 24 x 8	1 Stk		
	25	116649	Bushing d 15 x 19,5	2 Stk		
	26	F27761	Cylinder head screw DIN912 M 5 x 30	2 Stk		
	27	115987	Shaft d 10,7 x 50,5	1 Stk		
	28	115977	Disc d 11 x d 17,5 x 2,5	2 Stk		
	29	F20163	Hexagonal bolt DIN933 M 5 x 12	2 Stk		
	30	F21429	Cylinder head screw DIN912 M 6 x 60	2 Stk		
	31	F250798	Hexagonal nut DIN985 M 6	2 Stk		
	32	F24031	Spring lock washer DIN127 B 6	8 Stk		
	33	F26033	Hexagonal bolt DIN933 M 6 x 20	4 Stk		
	34	F25910	Hexagonal bolt DIN933 M 5 x 16	2 Stk		
	35	F20258	Washer DIN125 A 6,4	10 Stk		

		<i>Position No.</i>	<i>Part No.</i>	<i>Designation</i>	<i>Quantity</i>	
	36	115981	Pressure spring d 1,1 x Da 7,5 x 16	2 Stk		
	37	116647	Bracket 63,5 x 62,5 x 12	1 Stk		
	38	115982	Bracket 30 x 12 x 12	1 Stk		
	39	115991	Plate / sheet 108,5 x 31,2 x 3	1 Stk		
	40	115978	Distance Sleeve d 6,2 x d 12 x 7	2 Stk		
	41	116655	Plate /sheet 259,5 x 61 x 6	1 Stk		
	42	F20215	Rod End GIRS 14	1 Stk		
	43	116532	Housing 60 x 20 x 2	1 Stk		
	44	F21045	Washer DIN125 A 5,3	6 Stk		
	45	F28923	Cylinder head screw DIN912 M 5 x 20	2 Stk		
	500	F248498	Gear motor DC GMPD	1 Stk		
	501	116690	Proximity switch BI4-M12-AP6X-H1141	1 Stk		







		<i>Position No.</i>	<i>Part No.</i>	<i>Designation</i>	<i>Quantity</i>	
		505	F28923	Cylinder head screw DIN912 m 5 x 20	1 Stk	

## 3 - Hood - 113831



## 3 - Hood - 113831

		<i>Position No.</i>	<i>Part No.</i>	<i>Designation</i>	<i>Quantity</i>	
		1	113825	Hood IR 29	1 Stk	
		2	113829	Protective guard discharge IR 29	1 Stk	
		3	113437	Gas pressure spring 10-23-100-1/1050N-201-301 GA32	2 Stk	
		4	111108	Hinge 50 x 50 x 11,5	2 Stk	
		5	F21035	Disc Ø 6,5 x Ø 20 x 2	4 Stk	
		6	F20048	Countersunk bolt DIN7991 M 6 x 16	8 Stk	
		7	F250798	Hexagonal nut DIN985 M 6	4 Stk	
		8	113830	Bolt d 28 x 53,5	2 Stk	
		9	108801	Disc d 8,5 x d 15 x 2	6 Stk	
		10	F20134	Cap nut DIN917 M 8	4 Stk	
		11	113691	Bolt d 15 x 31	2 Stk	

		<i>Position No.</i>	<i>Part No.</i>	<i>Designation</i>	<i>Quantity</i>	
		12	F21243	Cylinder head screw DIN84 M 6 x 12	2 Stk	
		13	F20598	Countersunk bolt DIN7991 M 5 x 12	4 Stk	
		14	104912	Hexagonal nut DIN985 M 5	4 Stk	
		15	113823	Bracket 675 x 260 x 110 x 2,5	1 Stk	
		16	113824	Plate / sheet 673 x 267 x 3	1 Stk	
		17	F249175	Handle Ø 30 x 24	2 Stk	
		18	114102	Plate / sheet 50 x 18 x 1	2 Stk	

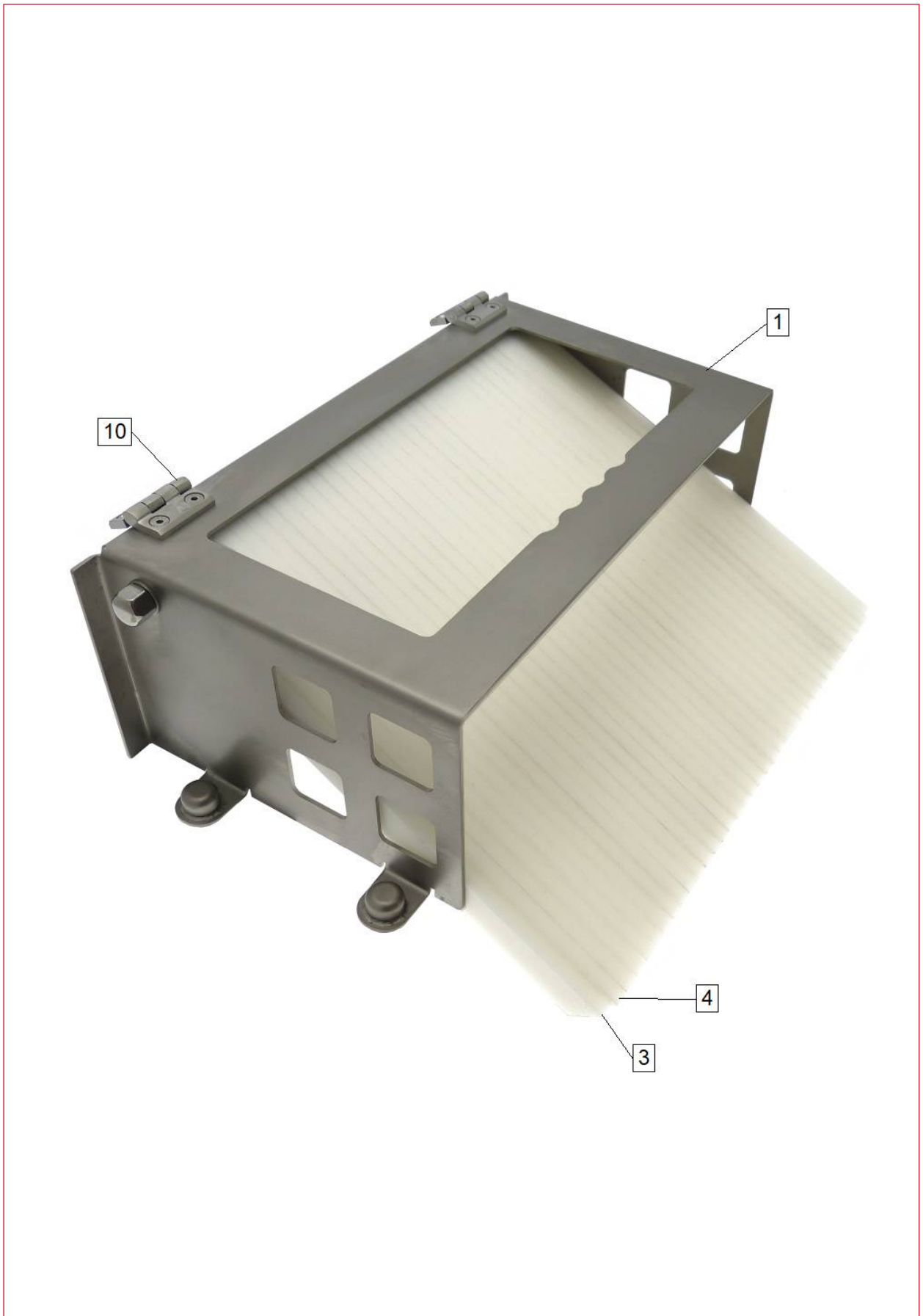

## 2 - Protective guard discharge - 113829





## 2 - Protective guard discharge - 113829

		<i>Position No.</i>	<i>Part No.</i>	<i>Designation</i>	<i>Quantity</i>	
		1	113827	Protective guard discharge IR 29	1 Stk	
		2	113828	Shaft d 10 x 393	1 Stk	
		3	109668	Protection lug 317 x 22 x 10	2 Stk	
		4	109168	Protection lug 320 x 22 x 10	34 Stk	
		5	114502	Ring d 10,5 x d 15 x 6	2 Stk	
		6	F27693	Washer DIN125 A 10,5	2 Stk	
		7	F20811	Cap nut DIN917 M 10	2 Stk	
		8	F20426	Solenoid d 10 x 10	2 Stk	
		9	105648	Bushing d 12 x 9	2 Stk	
		10	111810	Hinge 218-9301	2 Stk	
		11	F20598	Countersunk bolt DIN7991 M 5 x 12	4 Stk	

		<i>Position No.</i>	<i>Part No.</i>	<i>Designation</i>	<i>Quantity</i>	
		12	104912	Hexagonal nut DIN985 m 5	4 Stk	

## 4 - Needle beam - 115350

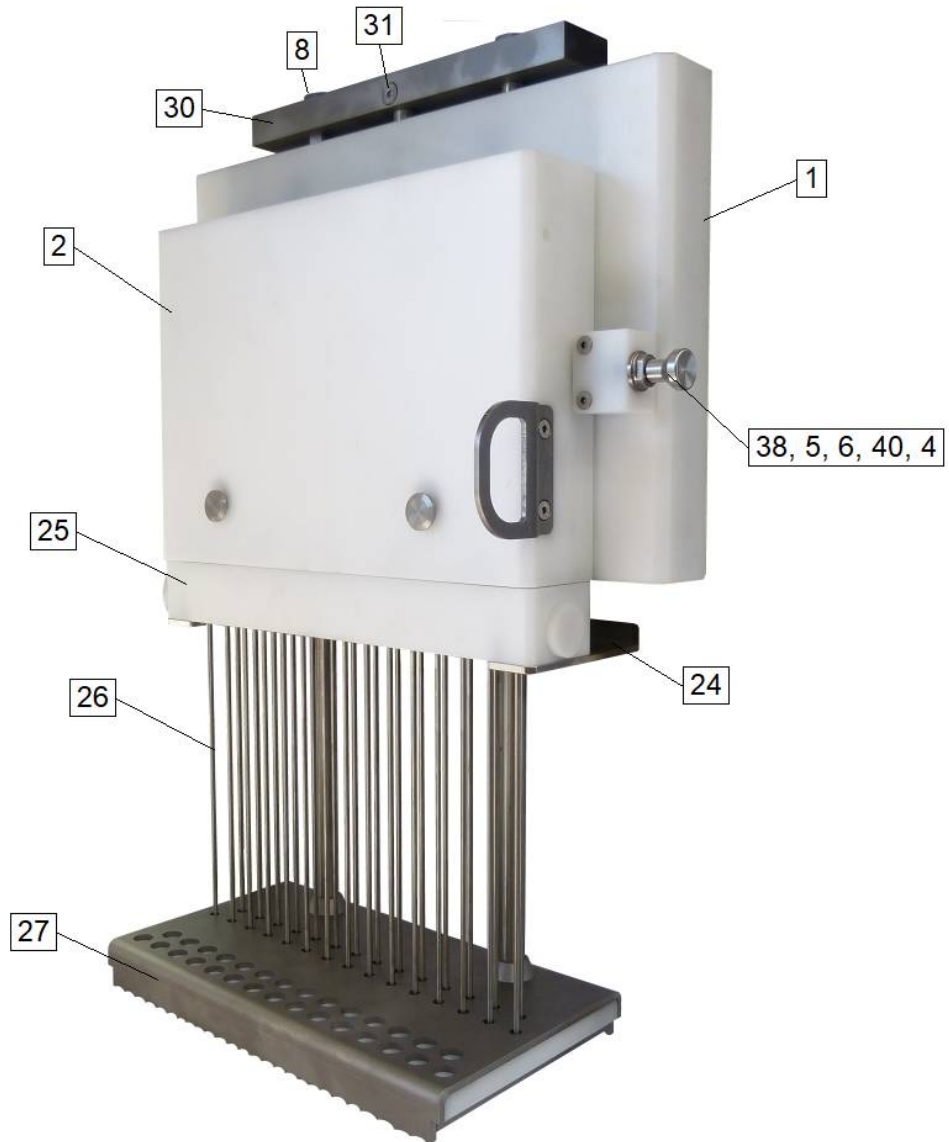

## 4 - Needle beam - 115350

		<i>Position No.</i>	<i>Part No.</i>	<i>Designation</i>	<i>Quantity</i>	
		1	115343	Block IR 29	1 Stk	
		2	113861	Block IR 29	1 Stk	
		3	111810	Hinge 218-9301	2 Stk	
		4	113703	Bolt d 12 x 71	1 Stk	
		5	106973	Lid M 22 x 1,5 x 21,5	1 Stk	
		6	F248042	Pressure spring d1.25 x De13.75 x 27	1 Stk	
		7	115344	Shaft d 20 x 295	1 Stk	
		8	F252764	Hexagonal nut DIN439 M 16 x 1,5	2 Stk	
		9	115336	Bushing d 25 x 19	2 Stk	
		10	115337	Bolt d 20 x 34,8	1 Stk	
		11	115338	Bolt d 20 x 45,8	1 Stk	

		<i>Position No.</i>	<i>Part No.</i>	<i>Designation</i>	<i>Quantity</i>	
		12	115348	Lever 25 x 10 x 90	2 Stk	
		13	116144	Shaft d 16 x 134	2 Stk	
		14	115339	Bolt d 10 x 23,5	4 Stk	
		15	113865	Disc d 16 x 2,5	2 Stk	
		16	113448	Slide bushing J3FM-12-14-09	2 Stk	
		17	109341	Disc d 8,3 x d 15 x 1	4 Stk	
		18	113450	Slide bushing J3FM - 0810-05	4 Stk	
		19	F250798	Hexagonal nut DIN985 M 6	4 Stk	
		20	F20048	Countersunk bolt DIN7991 M 6 x 16	2 Stk	
		21	113918	Bolt d 25 x 198,5	2 Stk	
		22	115331	Pressure spring d 1,17 x Da11,56 x 44,45	2 Stk	
		23	F20208	Countersunk bolt DIN7991 M 8 x 20	2 Stk	

		<i>Position No.</i>	<i>Part No.</i>	<i>Designation</i>	<i>Quantity</i>	
		24	115345	Bracket 380 x 132 x 44 x 5	1 Stk	
		25	113925	Distributor unit IR 29	1 Stk	
		26	115413	Curing needle d 4,0 x 331,5	29 Stk	
		27	116005	Plate IR 29	1 Stk	
		28	114275	Bushing d 20,5 x d 30 x 13	2 Stk	
		29	F20598	Countersunk bolt DIN7991 M 5 x 12	12 Stk	
		30	115347	Plate 320 x 50 x 25	1 Stk	
		31	F20834	Countersunk bolt DIN7991 M 8 x 35	1 Stk	
		32	113927	Connecting rod 360 x 35 x 12	1 Stk	
		33	114697	Slide bushing J3FM-1416-12	2 Stk	
		34	113876	Ring d 14,2 x d 25 x 1,8	2 Stk	
		35	F23418	Disc d 8,5 x d 35 x 3	2 Stk	

		<i>Position No.</i>	<i>Part No.</i>	<i>Designation</i>	<i>Quantity</i>	
		36	F21281	Hexagonal bolt DIN933 M 8 x 16	2 Stk	
		37	F21260	Spring lock washer DIN128 A 8	2 Stk	
		38	107647	Mushroom-shaped button M 6 VA	1 Stk	
		39	115346	Lid 169,6 x 124 x 2,5	1 Stk	
		40	113406	Disc d 10,5 x d 13,5 x 1	1 Stk	
		41	F20453	Countersunk bolt DIN7991 M 6 x 20	4 Stk	















## 1 - Block - 115343











## 1 - Block - 115343

		<i>Position No.</i>	<i>Part No.</i>	<i>Designation</i>	<i>Quantity</i>	
		1	115340	Block 480 x 330 x 60	1 Stk	
		2	106839	Slide bushing JUM-01-30	4 Stk	
		3	115341	Bushing M 44 x 1,5 x d 32 x 44	2 Stk	
		4	115342	Bushing M 44 x 1,5 x d 20,2 x 29	2 Stk	
		5	113844	Flange d 70 x 45	1 Stk	
		6	110011	Countersunk bolt DIN 7991 M 6 x 30	4 Stk	
		7	115334	Thread insert M6 x 12	10 Stk	
		8	113847	Shaft IR 29	2 Stk	
		9	F22368	Pressure spring d 3,0 x De38 x 350	2 Stk	
		10	115333	Thread insert M5 - d 10 x 12	8 Stk	
		11	113434	Slide bushing JUM - 01 - 12	2 Stk	

		<i>Position No.</i>	<i>Part No.</i>	<i>Designation</i>	<i>Quantity</i>	
		12	113735	Housing 50 x 40 x 35	1 Stk	
		13	113848	Countersunk bolt DIN7991 M 6 x 45	2 Stk	
		14	113433	Slide bushing JUM-01-20	3 Stk	
		15	F29317	O-ring d 24 x 3	2 Stk	
		16	114494	Pin d 17 x 20	4 Stk	
		17	F24735	Threaded pin DIN551 M 6 x 12	2 Stk	
		18	115332	Slide bushing JUM-02-20	2 Stk	

## 8 - Shaft - 113847

		<i>Position No.</i>	<i>Part No.</i>	<i>Designation</i>	<i>Quantity</i>	
		1	113845	Shaft d 20 x 706	2 Stk	
		2	113846	Disc d 28 x 14 x 3	2 Stk	
		3	113731	Bushing d 20,2 x d 37,5 x 27	1 Stk	

## 2 - Block - 113861

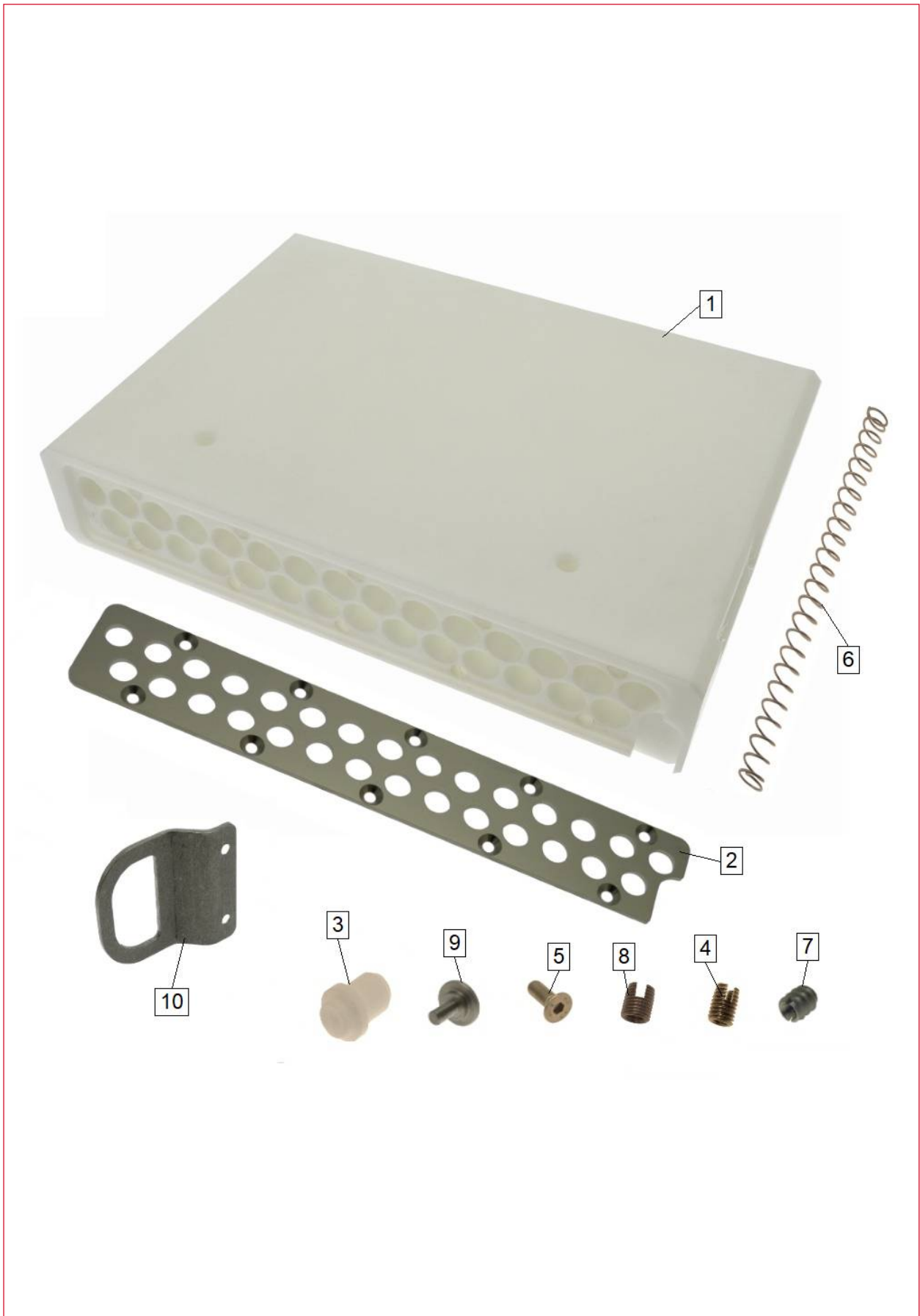

## 2 - Block - 113861





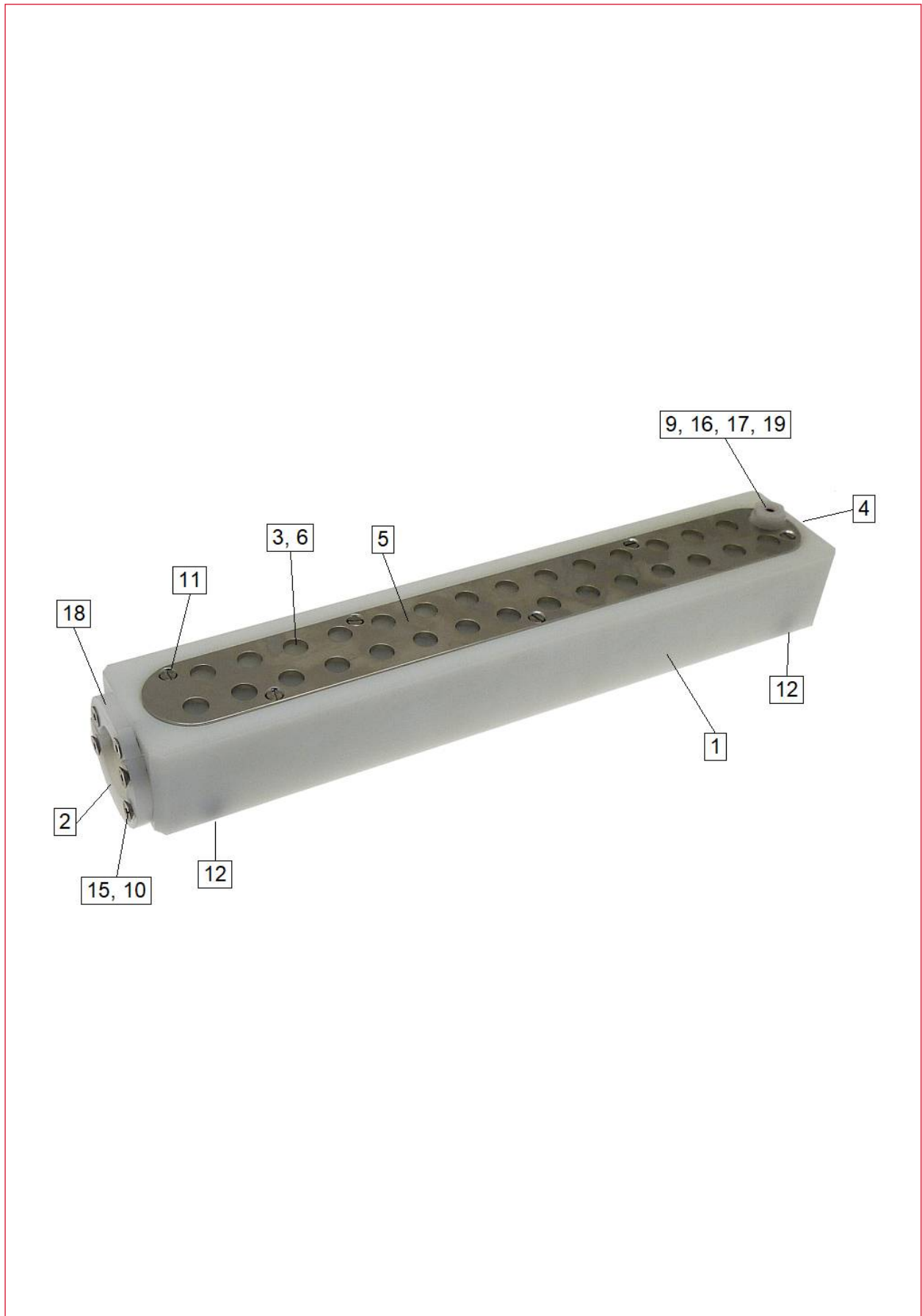



		<i>Position No.</i>	<i>Part No.</i>	<i>Designation</i>	<i>Quantity</i>	
	1	113858	Block 380 x 265 x 75	1 Stk		
	2	113859	Plate / sheet 350 x 60 x 4	1 Stk		
	3	F29306	Bolt d 19,5 x 25	29 Stk		
	4	F29102	Thread insert M6 x 12	12 Stk		
	5	F20048	Countersunk bolt DIN7991 M 6 x 16	12 Stk		
	6	F20114	Pressure spring d 1,8 x Di 15 x 280	29 Stk		
	7	115333	Thread insert M5 - d 10 x 12	4 Stk		
	8	F29103	Threaded insert M 8 x M12x1,5 x 15	2 Stk		
	9	113709	Pin d 25 x M8 x 21	2 Stk		
	10	113860	Handle 95 x 80 x 4	1 Stk		

## 25 - Distributor unit - 113925



## 25 - Distributor unit - 113925

		<i>Position No.</i>	<i>Part No.</i>	<i>Designation</i>	<i>Quantity</i>	
		1	113868	Block 380 x 68 x 48	1 Stk	
		2	109413	Guide d 60 x 7,5	1 Stk	
		3	114171	Bushing IR 29 / IR 17 / IR 17 Turbo	29 Stk	
		4	113728	Plug M 24 x 1,5 x d 35 x 12	1 Stk	
		5	113924	Plate 366 x 45 x 3	1 Stk	
		6	113444	Bushing d 20 x d 4,2 x 8,5	29 Stk	
		9	110476	Bushing d 18 x 19,5	1 Stk	
		10	F255839	Thread insert M5 - d 10 x 12	2 Stk	
		11	109058	Countersunk bolt DIN7972 3,9 x 16	6 Stk	
		12	F29102	Thread insert M6 x 12	4 Stk	
		15	F248555	Countersunk bolt DIN7991 M 5 x 20	2 Stk	







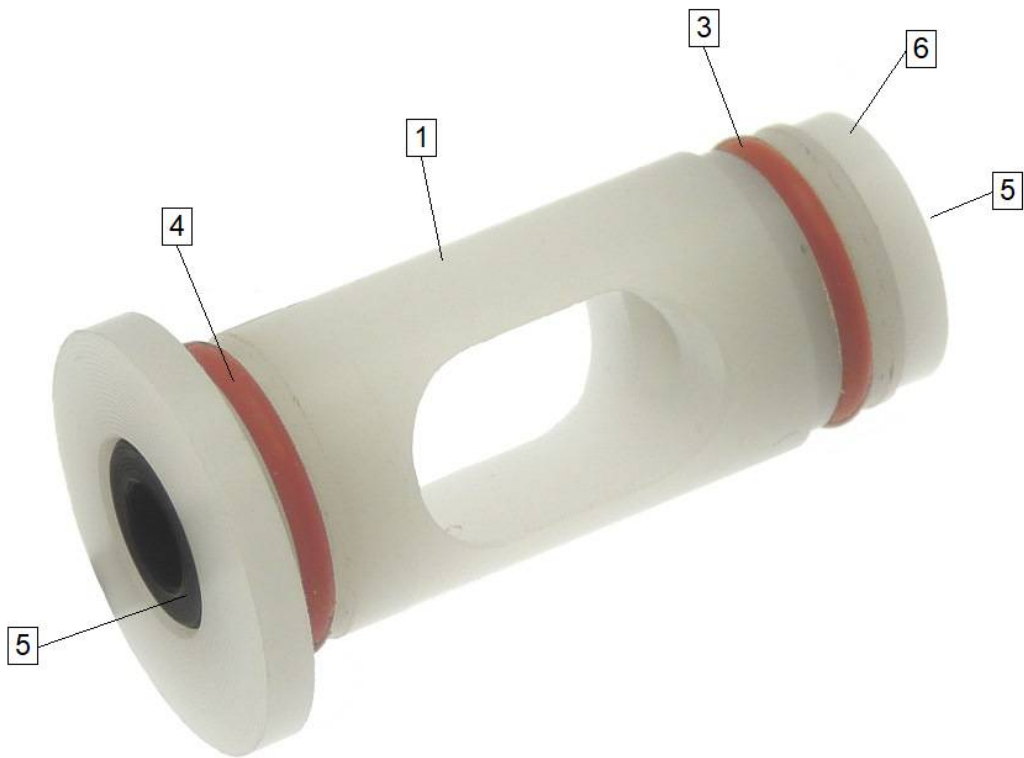



		<i>Position No.</i>	<i>Part No.</i>	<i>Designation</i>	<i>Quantity</i>	
		16	110308	O-ring d 6 x 3	1 Stk	
		17	108962	Hollow ball d 10	1 Stk	
		18	115349	Guide d 60 x 7,5	1 Stk	
		19	115564	Bushing d 10,7 x d 13 x 14	1 Stk	













## 3 - Bushing - 114171



## 3 - Bushing - 114171

		<i>Position No.</i>	<i>Part No.</i>	<i>Designation</i>	<i>Quantity</i>	
		1	113442	Bushing d 17,8 x 31,5	1 Stk	
		3	113446	O-ring d 9 x 1,5	1 Stk	
		4	113445	O-ring d 10 x 1,5	1 Stk	
		5	113452	Rod seal d 8 x d 4 x 3	2 Stk	
		6	113443	Lid d 11,5 x d 4,2 x 4,7	1 Stk	

## 27 - Plate - 116005

		<i>Position No.</i>	<i>Part No.</i>	<i>Designation</i>	<i>Quantity</i>	
		1	116002	Plate IR 29	1 Stk	
		2	116003	Plate 355 x 187 x 15	1 Stk	
		3	116004	Plate 341 x 187 x 10	1 Stk	
		4	116503	Countersunk bolt DIN7991 M 8 x 35	2 Stk	
		5	F20208	Countersunk bolt DIN7991 M 8 x 20	2 Stk	

## 5 - Cover - 113899



## 5 - Cover - 113899

		<i>Position No.</i>	<i>Part No.</i>	<i>Designation</i>	<i>Quantity</i>	
		1	113898	Cover IR 29	1 Stk	
		2	F20426	Solenoid d 10 x 10	1 Stk	
		3	105648	Bushing d 12 x 9	1 Stk	
		4	111810	Hinge 218-9301	2 Stk	
		5	F20598	Countersunk bolt DIN7991 M 5 x 12	8 Stk	
		6	104912	Hexagonal nut DIN985 M 5	4 Stk	

## 9 - Drive - 113947

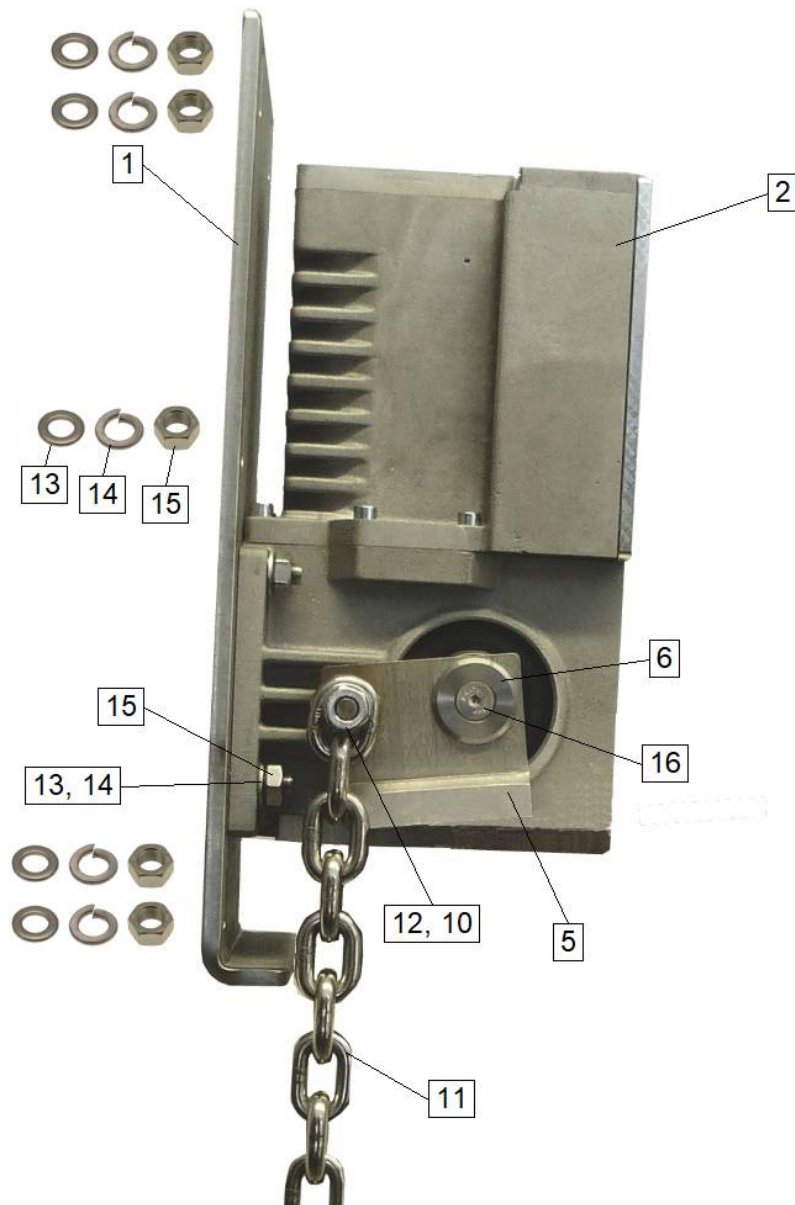

## 9 - Drive - 113947

		<i>Position No.</i>	<i>Part No.</i>	<i>Designation</i>	<i>Quantity</i>	
		1	113942	Housing IR 29	1 Stk	
		2	113576	Gear motor 1230-024	1 Stk	
		3	113943	Shaft d 30 x 128	1 Stk	
		4	108596	Adjusting spring A 8 x 7 x 90	1 Stk	
		5	113946	Lever IR 29	1 Stk	
		6	113874	Disc d 11,5 x d 35 x 3	1 Stk	
		7	F23418	Disc d 8,5 x d 35 x 3	1 Stk	
		8	F21281	Hexagonal bolt DIN933 M 8 x 16	1 Stk	
		9	113724	Ring d 30,2 x d 40 x 6	1 Stk	
		10	113835	Ring d 12,2 x d 17 x 4	2 Stk	
		11	113813	Round steel chain 8 x 24	1 Stk	

		<i>Position No.</i>	<i>Part No.</i>	<i>Designation</i>	<i>Quantity</i>	
		12	F21508	Hexagonal nut DIN439 M 10 x 1	2 Stk	
		13	F27693	Washer DIN125 A 10,5	9 Stk	
		14	F26379	Spring lock washer DIN127 B 10	9 Stk	
		15	F20147	Hexagonal nut DIN934 M 10	9 Stk	
		16	F26986	Countersunk bolt DIN7991 M 8 x 16	1 Stk	
		500	113627	Cable motor pump IR 29	1 Stk	





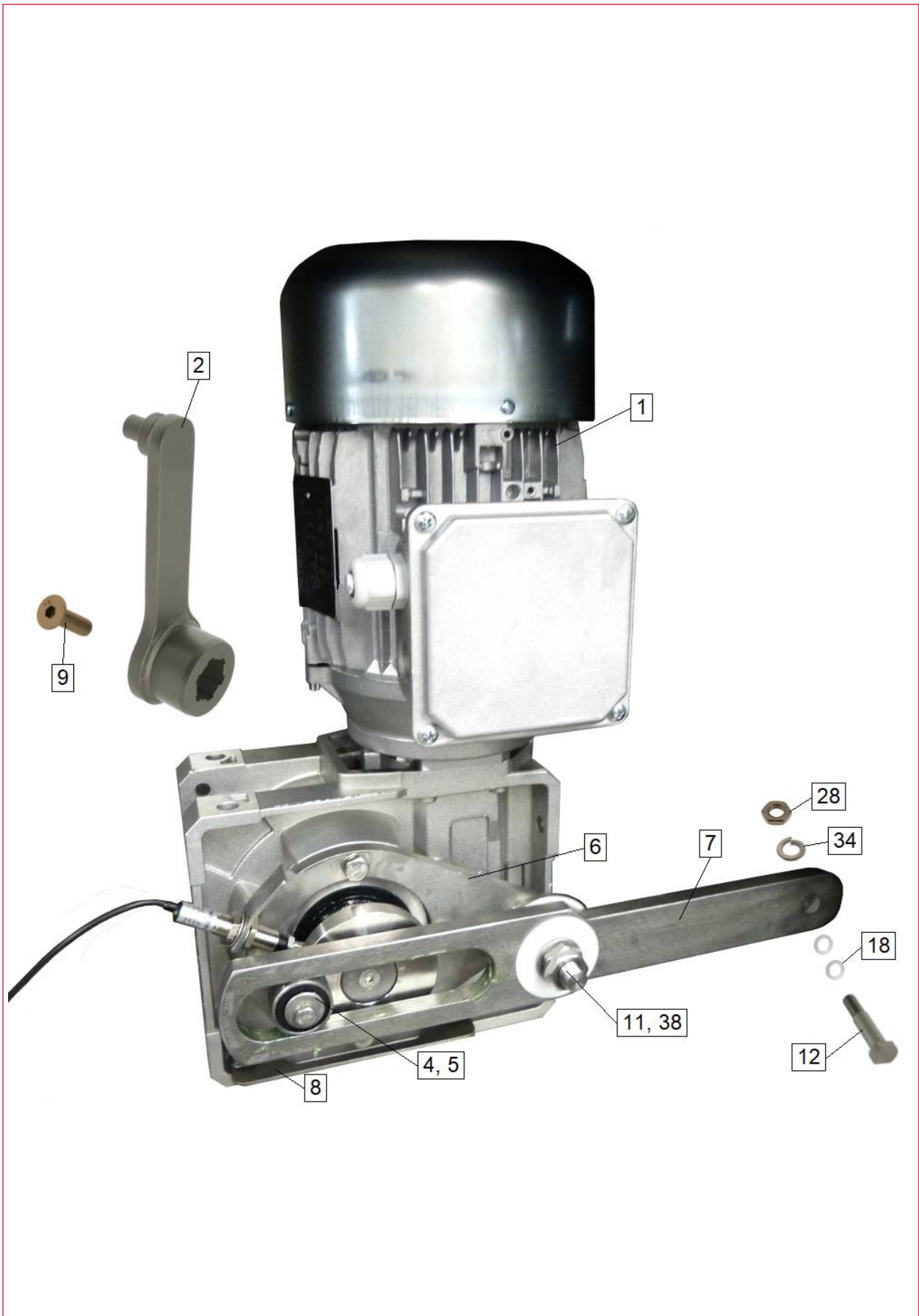





















## 10 - Drive - 113986









## 10 - Drive - 113986

		<i>Position No.</i>	<i>Part No.</i>	<i>Designation</i>	<i>Quantity</i>	
		1	113418	Gear motor M007FB09 MOC90Sb 2/4	1 Stk	
		2	113973	Lever IR 29 / IR 17 / IR 17 Turbo	1 Stk	
		3	113975	Shaft d 35 x 203	1 Stk	
		4	113979	Eccentric tappet IR 29	1 Stk	
		5	F27788	Tapered ball bearing DIN628 - 3201 2RS	1 Stk	
		6	113981	Flange 181,5 x 124 x 10	1 Stk	
		7	113982	Lever 385 x 57 x 12	1 Stk	
		8	113984	Starting sheet IR 29	2 Stk	
		9	F20207	Countersunk bolt DIN7991 M 8 x 25	1 Stk	
		10	114697	Slide bushing J3FM-1416-12	1 Stk	
		11	113700	Bolt d 25 x 98	1 Stk	

		<i>Position No.</i>	<i>Part No.</i>	<i>Designation</i>	<i>Quantity</i>	
		12	113701	Bolt d 22 x 58	1 Stk	
		13	113725	Bushing d 14,5 x d 18 x 20	1 Stk	
		14	F20202	Washer DIN125 A 13	1 Stk	
		15	F20204	Hexagonal nut DIN934 M 12	1 Stk	
		16	113722	Ring d 14,2 x d 40 x 2	1 Stk	
		17	107641	Disc d 14,5 x 35 x 4	1 Stk	
		18	113726	Disc d 14,2 x d 22 x 2	1 Stk	
		19	F21100	Adjusting spring A 8 x 7 x 45	2 Stk	
		20	F20222	Adjusting spring A 6 x 6 x 16	1 Stk	
		21	113985	Ring d 50 x d 60 x 14	1 Stk	
		22	109617	Disc d 7 x d 30 x 2	1 Stk	
		23	F20048	Countersunk bolt DIN7991 M 6 x 16	2 Stk	

		<i>Position No.</i>	<i>Part No.</i>	<i>Designation</i>	<i>Quantity</i>	
		24	F20217	Locking ring DIN471 Ø 30 x 1,5	1 Stk	
		25	F21260	Spring lock washer DIN128 A 8	8 Stk	
		26	F20259	Hexagonal nut DIN934 M 8	4 Stk	
		27	F20455	Hexagonal bolt DIN933 M 8 x 25	4 Stk	
		28	F20047	Hexagonal nut DIN439 M 10	2 Stk	
		30	F22918	Spring lock washer DIN127 B 14	1 Stk	
		31	F21035	Disc Ø 6,5 x Ø 20 x 2	1 Stk	
		32	F24031	Spring lock washer DIN127 B 6	1 Stk	
		33	F21047	Hexagonal bolt DIN933 M 6 x 12	1 Stk	
		34	F26379	Spring lock washer DIN127 B 10	1 Stk	
		35	F22888	Washer DIN125 A 8,4	4 Stk	
		36	114089	Ring d 14,1 x d 60 x 5	1 Stk	

		<i>Position No.</i>	<i>Part No.</i>	<i>Designation</i>	<i>Quantity</i>	
		37	114090	Ring d 22,2 x d 60 x 3	1 Stk	
		38	F26133	Hexagonal nut DIN439 M 14	2 Stk	
		39	114175	Plate / sheet 50 x 20 x 0,5	2 Stk	

## 11 - Softer - 113958



## 11 - Softer - 113958















		<i>Position No.</i>	<i>Part No.</i>	<i>Designation</i>	<i>Quantity</i>	
		1	113884	Block 388 x 280 x 68	1 Stk	
		2	113951	Plate / sheet 350 x 60 x 4	1 Stk	
		3	F29102	Thread insert M6 x 12	14 Stk	
		4	F20048	Countersunk bolt DIN7991 M 6 x 16	14 Stk	
		5	114047	Shackle IR 29/59	2 Stk	
		7	113409	Locking bolt GN 817-8-8-G-Ni	2 Stk	
		8	113955	Softer knife IR 29	29 Stk	
		9	107647	Mushroom-shaped button M 6 VA	2 Stk	
		10	F20114	Pressure spring d 1,8 x Di 15 x 280	29 Stk	
		11	F21307	Ring d 10,2 x d 19 x 2	29 Stk	

## 12 - Swivel - 113991





## 12 - Swivel - 113991

		<i>Position No.</i>	<i>Part No.</i>	<i>Designation</i>	<i>Quantity</i>	
		1	109546	Swivel IR 29 / IR 17 / IR 59	1 Stk	
		2	109547	Swivel IR 29 / IR 17 / IR 59	1 Stk	
		3	109538	Slide bushing iglidur A180	2 Stk	
		4	109046	O-ring d 21,95 x 1,78	2 Stk	
		5	109386	Guide d 45 x 30,3	4 Stk	
		6	110219	Clamp d 46 x 7	2 Stk	
		7	109045	O-ring Ø 23,52 x 1,78	1 Stk	





## 13 - Housing - 114003



## 13 - Housing - 114003

		<i>Position No.</i>	<i>Part No.</i>	<i>Designation</i>	<i>Quantity</i>	
		1	113993	Housing IR 29	1 Stk	
		2	F27629	Slide bushing GSM-3034-20	1 Stk	
		3	113998	Bushing d 60 x 38	1 Stk	
		4	F29102	Thread insert M6 x 12	1 Stk	
		5	114000	Housing IR 29	1 Stk	
		6	113894	Bushing d 74 x 29	1 Stk	
		7	F24009	Adjusting spring A 8 x 7 x 25	1 Stk	
		8	113835	Ring d 12,2 x d 17 x 4	2 Stk	
		9	F21508	Hexagonal nut DIN439 M 10 x 1	2 Stk	
		11	F22888	Washer DIN125 A 8,4	4 Stk	
		12	F21260	Spring lock washer DIN128 A 8	4 Stk	

---



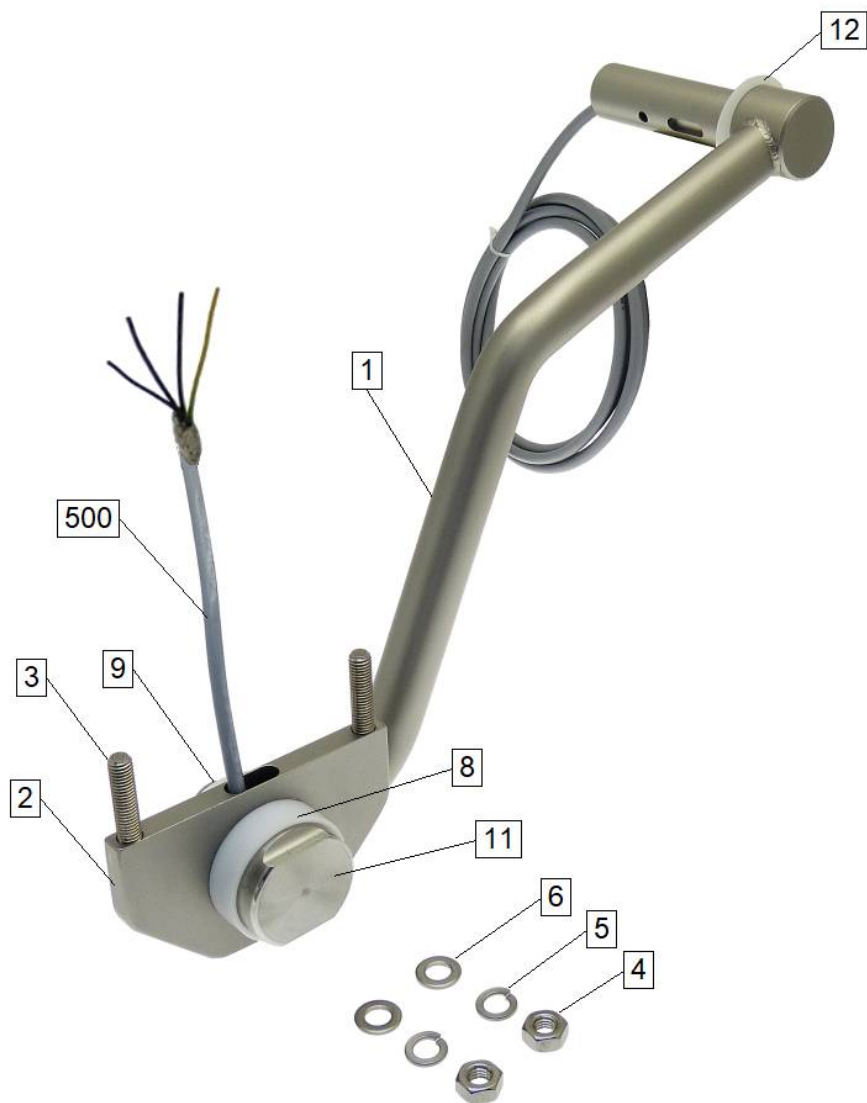

		<i>Position No.</i>	<i>Part No.</i>	<i>Designation</i>	<i>Quantity</i>	
		13	F22449	Hexagonal bolt DIN933 m 8 x 20	4 Stk	
		14	F20130	Cylinder head screw DIN912 m 6 x 20	1 Stk	

## 14 - Arm - 114555















## 14 - Arm - 114555

		<i>Position No.</i>	<i>Part No.</i>	<i>Designation</i>	<i>Quantity</i>	
		1	113978	Housing IR 29 / IR 17 Turbo	1 Stk	
		2	113988	Housing IR 29 / IR 17 Turbo	1 Stk	
		3	F26684	Drawn arc stud M 10 x 55	2 Stk	
		4	F20147	Hexagonal nut DIN934 M 10	2 Stk	
		5	F26379	Spring lock washer DIN127 B 10	2 Stk	
		6	F27693	Washer DIN125 A 10,5	2 Stk	
		7	113402	Grooved ball bearing DIN625 - 6005 2RS	2 Stk	
		8	113719	Disc d 33 x d 58 x 17	1 Stk	
		9	113718	Disc d 33 x d 58 x 15,5	1 Stk	
		10	114162	Disc d 25,2 x 52 x 1,5	1 Stk	
		11	113967	Lid d 52 x 13	1 Stk	

		<i>Position No.</i>	<i>Part No.</i>	<i>Designation</i>	<i>Quantity</i>	
		12	113720	Disc d 30,2 x d 50 x 2	1 Stk	
		500	113625	Cable pump drive IR 29	1 Stk	

## 500 - Cable pump drive - 113625

		<i>Position No.</i>	<i>Part No.</i>	<i>Designation</i>	<i>Quantity</i>	
	500	113584	Cable ÖCYZ-J 4 x 0,75 mm <sup>2</sup>	3000 mm		
	501	F20709	Cable end sleeve 0,75 mm <sup>2</sup> grey	4 Stk		
	502	F28135-W	Labeling cable W	40 mm		
	503	F28135-3	Labeling cable 3	40 mm		
	504	F27687	Crimp type socket 620/5, red isolated	4 Stk		
	505	F27645	Shrink hose HIS - 3/8", black	250 mm		



















## 15 - Conveyor belt - 113821



## 15 - Conveyor belt - 113821























		<i>Position No.</i>	<i>Part No.</i>	<i>Designation</i>	<i>Quantity</i>	
		1	113807	Conveyor belt IR 29	1 Stk	
		2	113809	Discharge IR 29	1 Stk	
		3	113814	Shaft d 14 x 346	3 Stk	
		4	113815	Shaft d 14 x 352	1 Stk	
		5	113816	Shaft d 14,5 x d 28 x 345	1 Stk	
		6	113817	Shaft d 14,5 x d 28 x 351	1 Stk	
		7	F21047	Hexagonal bolt DIN933 M 6 x 12	8 Stk	
		8	113818	Shaft d 14,5 x d 25 x 345	2 Stk	
		9	113426	Support plate 306 x 25 x 10	5 Stk	
		10	113424	Support plate 596 x 25 x 10	7 Stk	
		11	113441	Base d 18 x 18,7 x 2°	4 Stk	

		<i>Position No.</i>	<i>Part No.</i>	<i>Designation</i>	<i>Quantity</i>	
		12	109588	Cylindrical pin Ø 5 x 18,5	4 Stk	
		13	110021	Bolt d 12 x 14,5	2 Stk	
		14	113819	Shaft d 15 x 346	1 Stk	
		15	110111	Support plate 65 x 20 x 10	3 Stk	
		16	F29102	Thread insert M6 x 12	2 Stk	
		17	109407	Countersunk head screw DIN 7972 3,9 x 9,5	18 Stk	
		18	113465	Wire mesh belt 344 mm	2600 mm	
		19	113466	Sleeve d 2,5 x d 3 x 50	3 Stk	



## 16 - Pump - 114009



## 16 - Pump - 114009

		<i>Position No.</i>	<i>Part No.</i>	<i>Designation</i>	<i>Quantity</i>	
		1	113467	Pump ZAT14X-50/20-X60	1 Stk	
		3	113987	Piping IR 29 / IR 17 Turbo	1 Stk	
		4	113877	Guide d 45 x 17	4 Stk	
		5	113747	Slide bushing iglidur A180	2 Stk	
		6	109046	O-ring d 21,95 x 1,78	2 Stk	
		7	110219	Clamp d 46 x 7	2 Stk	
		16	113965	Motor protect d 204 x 240 x 1,5	1 Stk	
		17	113970	Motor protect d 204 x 70	1 Stk	
		18	113971	Motor protect d 204 x 42	1 Stk	
		19	F20598	Countersunk bolt DIN7991 M 5 x 12	4 Stk	
		20	F248555	Countersunk bolt DIN7991 M 5 x 20	4 Stk	

		<i>Position No.</i>	<i>Part No.</i>	<i>Designation</i>	<i>Quantity</i>	
		21	F255839	Thread insert M5 - d 10 x 12	4 Stk	
		22	114061	Disc d 152 x 2	1 Stk	
		23	109407	Countersunk head screw DIN 7972 3,9 x 9,5	4 Stk	
		24	113759	Filter plate 178 x 155 x 41,5 x 1,5	1 Stk	
		25	107046	Bolt d 15 x 48	3 Stk	
		26	F26993	Hexagonal bolt DIN933 M 5 x 10	3 Stk	
		27	F248555	Countersunk bolt DIN7991 M 5 x 20	4 Stk	
		28	114068	Frame 100 x 100 x 8	1 Stk	
		29	114069	Lid 94 x 94 x 2	1 Stk	
		30	114067	Piping IR 29 / IR 17 Turbo	1 Stk	
		31	114960	Nut d 30 x 22	1 Stk	
		32	F21636	Cable end sleeve 4,0 mm <sup>2</sup> grey	1 Stk	













		<i>Position No.</i>	<i>Part No.</i>	<i>Designation</i>	<i>Quantity</i>	
		33	F144452	Squash connector FTS-1 red isolated	1 Stk	





## 17 - Lid - 114014





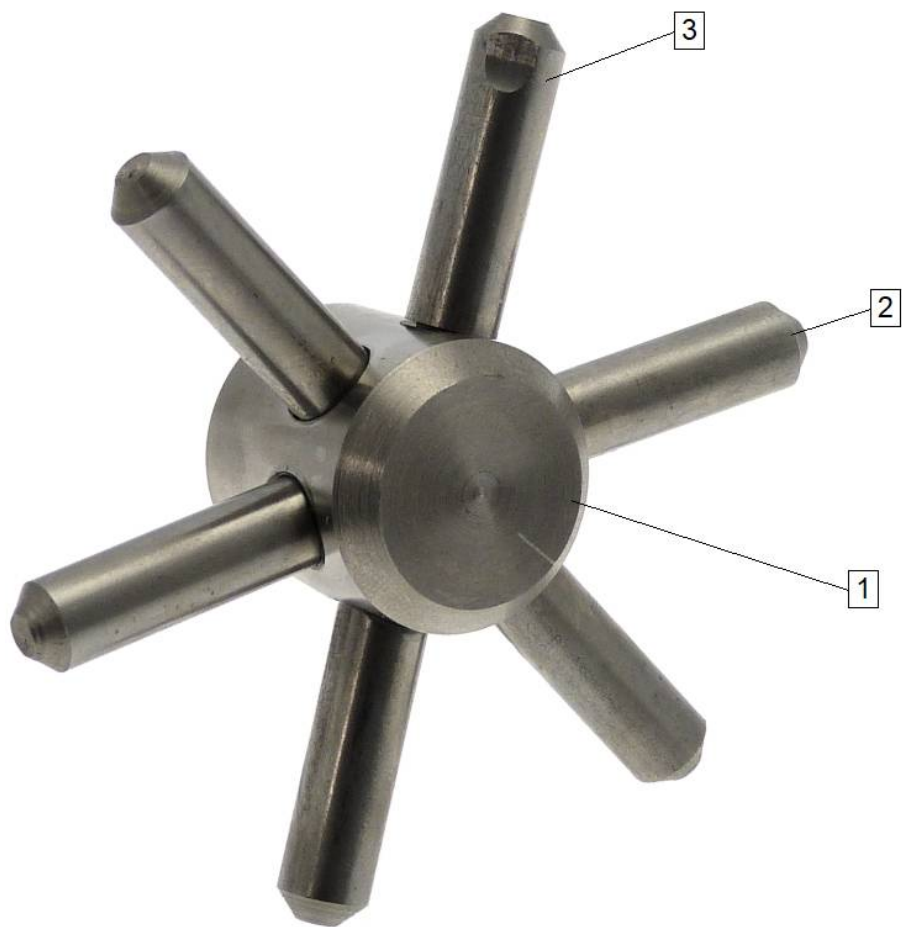

		<i>Position No.</i>	<i>Part No.</i>	<i>Designation</i>	<i>Quantity</i>	
		1	114013	Lid IR 29	1 Stk	
		3	111005	Disc d 25 x 12	1 Stk	
		4	110999	Switch MPR / IR	1 Stk	
		5	111006	Disc d 25 x 6	1 Stk	
		8	113664	Foil 183 x 146	1 Stk	
		10	F20258	Washer DIN125 A 6,4	1 Stk	
		11	F24031	Spring lock washer DIN127 B 6	11 Stk	
		12	F250798	Hexagonal nut DIN985 M 6	11 Stk	
		13	F248478	Countersunk bolt DIN7991 M 4 x 10	11 Stk	
		14	113994	Display frame 160 x 110 x 1,5	1 Stk	
		15	113995	Display frame 160 x 110 x 3	1 Stk	

		<i>Position No.</i>	<i>Part No.</i>	<i>Designation</i>	<i>Quantity</i>	
		16	113996	Display frame 160 x 140 x 3	1 Stk	
		17	113997	Plate / sheet 100 x 100 x 4	1 Stk	
		18	111251	Clamp assembly RLFZ (x10)	1 Stk	
		19	114283	Plate 100 x 100 x 6	1 Stk	
		20	112370	Cylinder head screw DIN912 M 4 x 16	2 Stk	
		21	F250796	Hexagonal nut DIN985 M 4	2 Stk	

## 4 - Switch - 110999





















## 4 - Switch - 110999

		<i>Position No.</i>	<i>Part No.</i>	<i>Designation</i>	<i>Quantity</i>	
		1	111002	Housing d 25 x 25	1 Stk	
		2	111001	Pin d 8 x 32	5 Stk	
		3	111003	Pin d 8 x 35,5	1 Stk	

## 18 - Mechanical components - 114072



## 18 - Mechanical components - 114072

		<i>Position No.</i>	<i>Part No.</i>	<i>Designation</i>	<i>Quantity</i>	
		1	109482	Seal 9 x 2 black	2650 mm	
		2	F20811	Cap nut DIN917 M 10	12 Stk	
		3	113726	Disc d 14,2 x d 22 x 2	8 Stk	
		4	113721	Ring d 14,2 x d 50 x 2	4 Stk	
		5	113477	Slide bushing GSM 1416-08	4 Stk	
		6	113878	Bolt d 15 x 37	4 Stk	
		7	F28959	Ring d 15,2 x d 25 x 2	2 Stk	
		8	113883	Plate 353 x 330 x 15	1 Stk	
		9	113694	Bolt d 14 x 45,2	4 Stk	

## 500 - Switch box - 113649

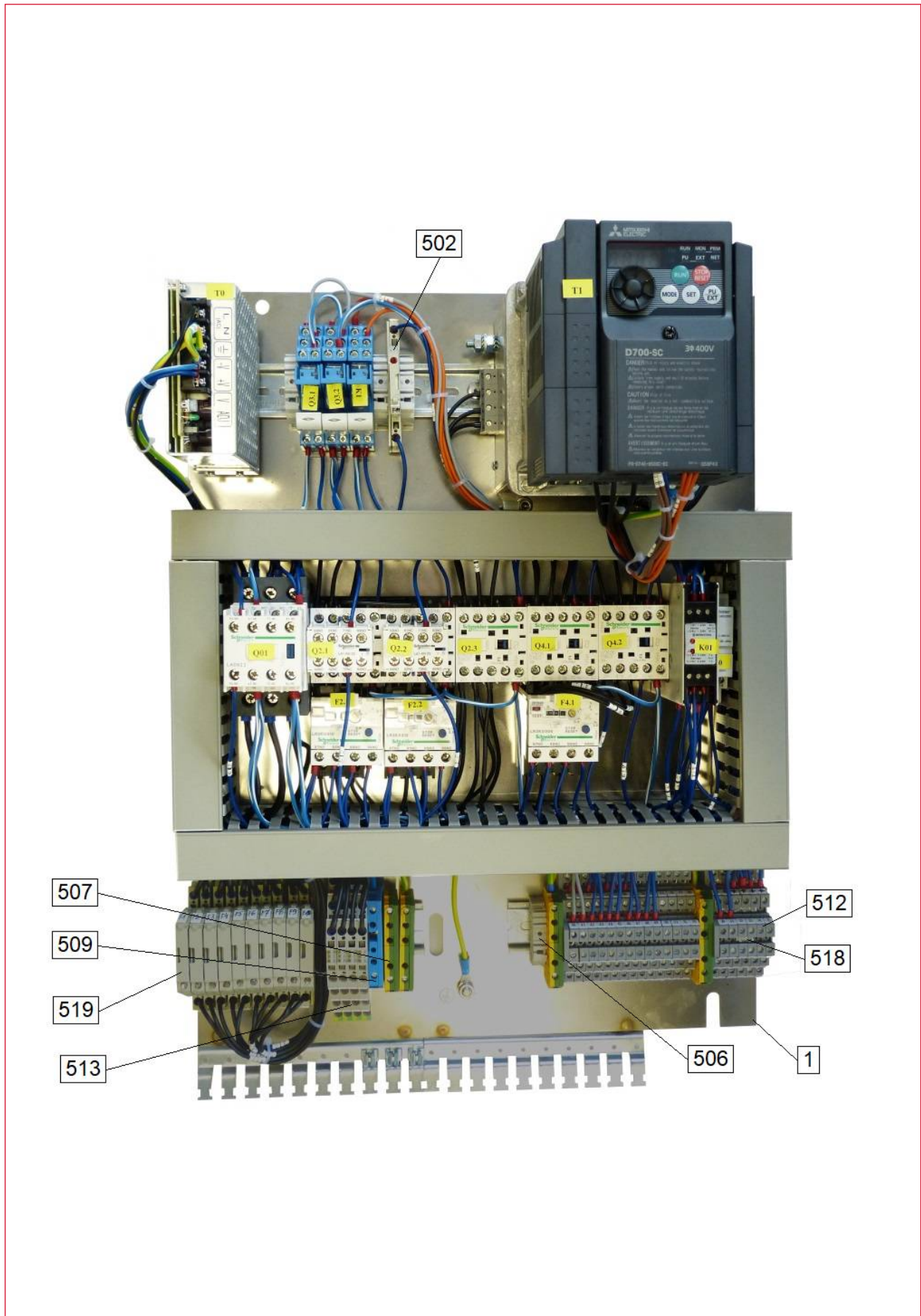

## 500 - Switch box - 113649

		<i>Position No.</i>	<i>Part No.</i>	<i>Designation</i>	<i>Quantity</i>	
		1	114063	Mounting plate IR 29 / IR 17 Turbo	1 Stk	
		2	114012	Bracket 85 x 40 x 2	1 Stk	
		3	F28731	Cable duct 80 x 30 x 2000	380 mm	
		4	F28731	Cable duct 80 x 30 x 2000	160 mm	
		5	F20146	Top-hat rail 35 x 7.5 x 2000	380 mm	
		6	F20146	Top-hat rail 35 x 7.5 x 2000	320 mm	
		7	F20146	Top-hat rail 35 x 7.5 x 2000	190 mm	
		8	110986	Flanged plate 130 x 120 x 6	1 Stk	
		500	113647	Components IR 29	1 Stk	
		501	104292	Grounding fuse terminal 5,0 x 20 mm / 6,3 x 32 mm	11 Stk	
		502	114163	Fuse disconnect lever THSI 5x20 LED 24, 24V, 6,3A	1 Stk	



		<i>Position No.</i>	<i>Part No.</i>	<i>Designation</i>	<i>Quantity</i>	
		503	110837	Side plate grey APFN 4 D2/2	11 Stk	
		504	114164	Fuse 3,15 A FF 5,0 x 20 mm	2 Stk	
		505	105012	Fuse 6,3 AT 6,3 x 32 mm	6 Stk	
		506	F28278	End terminal BNK - BADL	5 Stk	
		507	F20719	Protective conductor terminal 2x 4mm <sup>2</sup>	4 Stk	
		508	F28277	Side plate green FEM 4AP	3 Stk	
		509	F27054	Terminal - 2x, blue 4mm <sup>2</sup>	1 Stk	
		510	F20721	Side plate blue FEM 4A	1 Stk	
		511	F27053	Terminal - 3x, grey 2.5mm <sup>2</sup>	20 Stk	
		512	F28338	Side plate grey FED 3E	2 Stk	
		513	107605	Terminal - 3x, with PE 4mm <sup>2</sup>	6 Stk	
		514	F247637	Labeling 1 - 100	1 Stk	





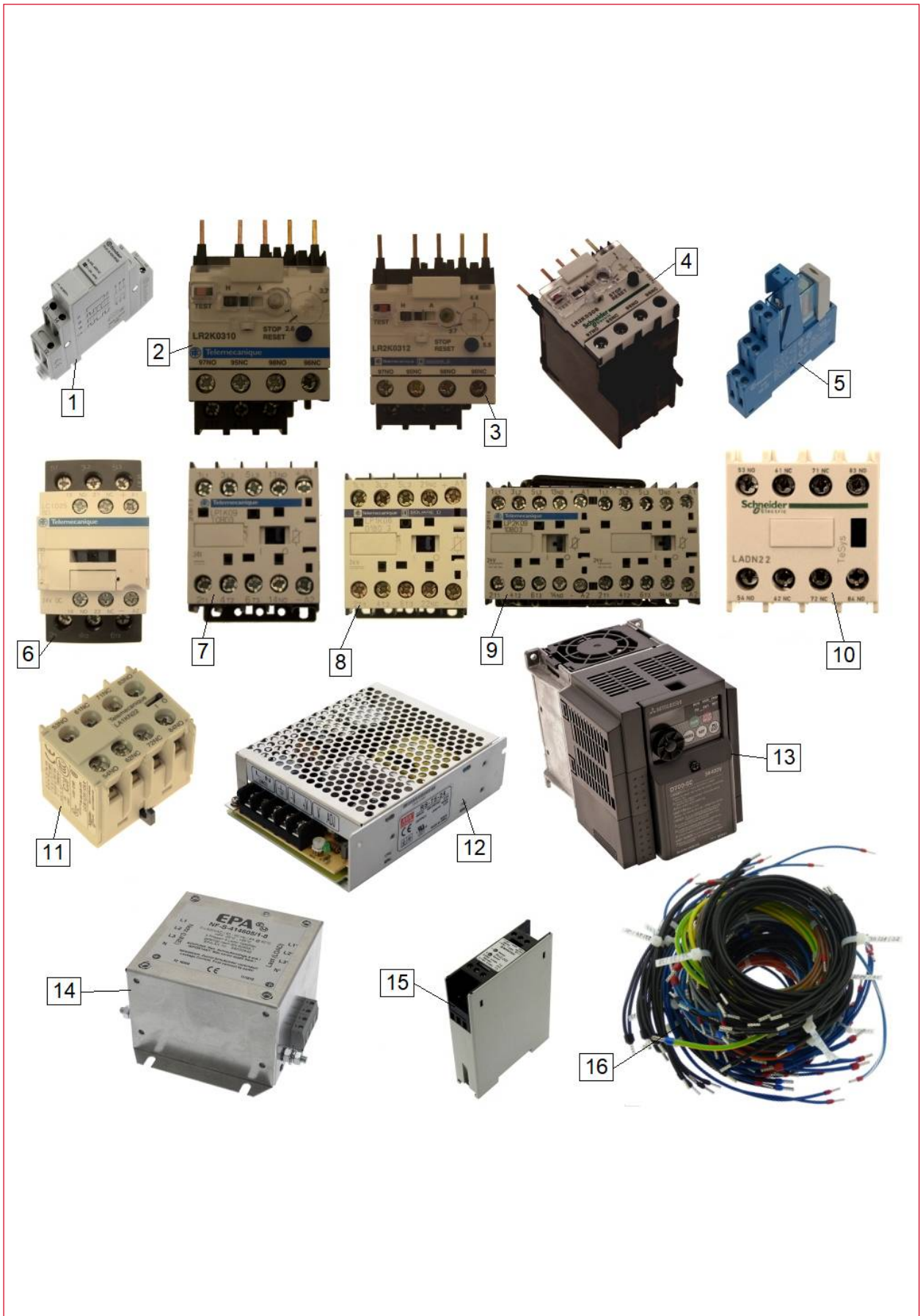





		<i>Position No.</i>	<i>Part No.</i>	<i>Designation</i>	<i>Quantity</i>	
		515	109971	Labeling 1-2-3-4-5-1-2-3-4-5	1 Stk	
		516	F25823	Cable tie 23 m	40 Stk	
		517	F26021	Fuse 8.0 AT 6,3 x 32 mm	12 Stk	
		518	F28275	Cross connector unisolated BJD 6	13 Stk	
		519	104294	Fuse disconnect lever THSI 6.3x32 GL250, 250V 10A	10 Stk	
		520	105011	Fuse 3.15 AT 6,3 x 32 mm	2 Stk	
		521	F148541	Sticker BMK02	1 Stk	
		522	110118	Mounting foot SF single	1 Stk	

## 500 - Components - 113647









































## 500 - Components - 113647

		<i>Position No.</i>	<i>Part No.</i>	<i>Designation</i>	<i>Quantity</i>	
	1	112007	Phase sequence relay 70.61.8.400.0000	1 Stk		
	2	F22287	Motor protect relay 2.6 -3.7 A LR 2-K0310	1 Stk		
	3	F27076	Motor protect relay 3.7 -5.5 A LR 2-K0312	1 Stk		
	4	F20911	Motor protect. relay 0.8 -1.2A LR 2-K0306	1 Stk		
	5	112466	Relay 1 CO / 24 VDC / 10A	3 Stk		
	6	101590	Power contactor 24VDC LC1 D25 BD	1 Stk		
	7	F27091	Power contactor 24VDC LP1 K0910 BD3	1 Stk		
	8	F26434	Power contactor 24VDC LP1 K0601 BD3	2 Stk		
	9	F20916	Turn contactor LP2-K0910 BD3	1 Stk		
	10	104243	Aux. switch block LAD N22	1 Stk		
	11	106925	Aux. switch block LA1 KN22	2 Stk		











		<i>Position No.</i>	<i>Part No.</i>	<i>Designation</i>	<i>Quantity</i>	
		12	111353	Power supply 230VAC/24VDC RS-75-24	1 Stk	
		13	113650	Programmed FC FR-D740-050 SC-EC	1 Stk	
		14	110963	Line filter 8A EPA NF-S-414605/1-8	1 Stk	
		15	F28956	Monitoring unit MÜZ 202/D24-FL	1 Stk	
		16	113648	Multi-wire cable set IR 29	1 Stk	

## 501 - Cable set - 113621

		<i>Position No.</i>	<i>Part No.</i>	<i>Designation</i>	<i>Quantity</i>	
		500	113623	Cable supply IR 29	1 Stk	
		501	113624	Cable supply IR 29	1 Stk	
		503	113626	Cable conveyer belt / beam dri IR 29	1 Stk	
		505	113628	Cable motor belt feed adjustm. IR 29	1 Stk	
		506	113629	Bracket with cable IR 29	1 Stk	
		508	113631	Bracket with cable IR 29	1 Stk	
		509	113632	Cable switch S4 IR 29	1 Stk	
		510	113633	Proximity switch B2 with cable IR 29	1 Stk	
		511	113634	Proximity switch B3 with cable IR 29	1 Stk	
		512	113635	Cable pressure transmitter IR 29	1 Stk	
		513	113636	Cable digital outputs IR 29	1 Stk	









		<i>Position No.</i>	<i>Part No.</i>	<i>Designation</i>	<i>Quantity</i>	
		514	113637	Cable analog outputs IR 29	1 Stk	
		515	113638	Cable power supply display IR 29	1 Stk	
		516	113639	Cable digital inputs IR 29	1 Stk	
		517	113640	Cable analog inputs IR 29	1 Stk	
		518	113641	Cable expansion card IR 29	1 Stk	
		519	114083	Ground wire IR 29	1 Stk	
		520	114084	Ground wire IR 29	1 Stk	
		521	114085	Ground wire IR 29	1 Stk	

## 500 - Cable supply - 113623











		<i>Position No.</i>	<i>Part No.</i>	<i>Designation</i>	<i>Quantity</i>	
	500	F27555	Cable H07RN-F 5G2.5	6000 mm		
	501	F27734	Cable end sleeve 2,5 mm² blue	10 Stk		
	502	F28135-W	Labeling cable W	60 mm		
	503	F28135-1	Labeling cable 1	60 mm		
	504	f26441	CEE plug 16A-6h 5-pin 400V	1 Stk		











## 501 - Cable supply - 113624

		<i>Position No.</i>	<i>Part No.</i>	<i>Designation</i>	<i>Quantity</i>	
	500	F27555	Cable H07RN-F 5G2.5	1200 mm		
	501	F27734	Cable end sleeve 2,5 mm² blue	10 Stk		
	502	F28135-W	Labeling cable W	60 mm		
	503	F28135-2	Labeling cable 2	60 mm		





## 503 - Cable conveyer belt / beam dri - 113626

		<i>Position No.</i>	<i>Part No.</i>	<i>Designation</i>	<i>Quantity</i>	
	500	F23730	Cable ÖZ-J 7 x 1.5 mm <sup>2</sup>	1600 mm		
	501	F27324	Cable end sleeve 1,5 mm <sup>2</sup> black	7 Stk		
	502	F27686	Crimp type socket 620/4, red isolated	7 Stk		
	503	F28135-W	Labeling cable W	40 mm		
	504	F28135-4	Labeling cable 4	40 mm		











## 505 - Cable motor belt feed adjustm. - 113628

		<i>Position No.</i>	<i>Part No.</i>	<i>Designation</i>	<i>Quantity</i>	
		500	F20694	Cable ÖZ-0 2 x 0.5 mm <sup>2</sup>	1500 mm	
		501	F27358	Cable end sleeve 0,5 mm <sup>2</sup> white	4 Stk	
		502	F28135-W	Labeling cable W	40 mm	
		503	F28135-6	Labeling cable 6	40 mm	











## 506 - Bracket with cable - 113629

		<i>Position No.</i>	<i>Part No.</i>	<i>Designation</i>	<i>Quantity</i>	
		1	113869	Bracket 476 x 120 x 99 x 2	1 Stk	
		500	F20741	Solenoid switch MAK 2626-2	2 Stk	
		501	F27789	Cable end sleeve 0,25 mm <sup>2</sup> yellow	8 Stk	
		502	F28135-W	Labeling cable W	40 mm	
		503	F28135-7	Labeling cable 7	40 mm	
		504	F28135-W	Labeling cable W	40 mm	
		505	F28135-8	Labeling cable 8	40 mm	













## 508 - Bracket with cable - 113631

		<i>Position No.</i>	<i>Part No.</i>	<i>Designation</i>	<i>Quantity</i>	
		1	F240681a	Bracket 85,5 x 63 x 30 x 2,5	1 Stk	
		500	F20741	Solenoid switch MAK 2626-2	1 Stk	
		501	F27789	Cable end sleeve 0,25 mm <sup>2</sup> yellow	4 Stk	
		502	F28135-W	Labeling cable W	40 mm	
		503	F28135-9	Labeling cable 9	40 mm	

## 509 - Cable switch S4 - 113632

		<i>Position No.</i>	<i>Part No.</i>	<i>Designation</i>	<i>Quantity</i>	
		500	F28791	Cable ÖZ-O 4x0.75 mm <sup>2</sup>	1150 mm	
		501	F20709	Cable end sleeve 0,75 mm <sup>2</sup> grey	6 Stk	
		502	F28135-W	Labeling cable W	40 mm	
		503	F28135-1	Labeling cable 1	40 mm	
		504	F28135-0	Labeling cable 0	40 mm	

## 510 - Proximity switch B2 with cable - 113633

		<i>Position No.</i>	<i>Part No.</i>	<i>Designation</i>	<i>Quantity</i>	
	1	113932	Bracket 81 x 72 x 22,5 x 2,5	1 Stk		
	500	F27081	Proximity switch KIN-M12PS/004 KL6	1 Stk		
	501	F27789	Cable end sleeve 0,25 mm <sup>2</sup> yellow	3 Stk		
	502	F28135-W	Labeling cable W	40 mm		
	503	F28135-1	Labeling cable 1	40 mm		
	504	F28135-1	Labeling cable 1	40 mm		

## 511 - Proximity switch B3 with cable - 113634











		<i>Position No.</i>	<i>Part No.</i>	<i>Designation</i>	<i>Quantity</i>	
	1	113933	Bracket 75 x 40,5 x 59 x 4	1 Stk		
	500	F27081	Proximity switch KIN-M12PS/004 KL6	1 Stk		
	501	F27789	Cable end sleeve 0,25 mm <sup>2</sup> yellow	3 Stk		
	502	F28135-W	Labeling cable W	40 mm		
	503	F28135-1	Labeling cable 1	40 mm		
	504	F28135-2	Labeling cable 2	40 mm		



## 512 - Cable pressure transmitter - 113635

		<i>Position No.</i>	<i>Part No.</i>	<i>Designation</i>	<i>Quantity</i>	
		500	104173	Cable ÖCZY-J 3 x 0.5 mm <sup>2</sup>	1500 mm	
		501	F27358	Cable end sleeve 0,5 mm <sup>2</sup> white	3 Stk	
		502	F28754	Cable end sleeve 0,5 -1,0 mm <sup>2</sup> naked	3 Stk	
		503	F28135-W	Labeling cable W	40 mm	
		504	F28135-1	Labeling cable 1	40 mm	
		505	F28135-3	Labeling cable 3	40 mm	
		506	F20714	Shrink hose HIS - 1/4", black	60 mm	











## 513 - Cable digital outputs - 113636

		<i>Position No.</i>	<i>Part No.</i>	<i>Designation</i>	<i>Quantity</i>	
	500	F28102	Cable ÖZ-J 10x0.5 mm <sup>2</sup>	1350 mm		
	501	F27358	Cable end sleeve 0,5 mm <sup>2</sup> white	10 Stk		
	502	F28135-W	Labeling cable W	40 mm		
	503	F28135-1	Labeling cable 1	40 mm		
	504	F28135-4	Labeling cable 4	40 mm		











## 514 - Cable analog outputs - 113637

		<i>Position No.</i>	<i>Part No.</i>	<i>Designation</i>	<i>Quantity</i>	
	500	F28100	Cable Liycy 2 x 0.5 mm <sup>2</sup>	1200 mm		
	501	F27358	Cable end sleeve 0,5 mm <sup>2</sup> white	4 Stk		
	502	F28135-W	Labeling cable W	40 mm		
	503	F28135-1	Labeling cable 1	40 mm		
	504	F28135-5	Labeling cable 5	40 mm		
	505	F20714	Shrink hose HIS - 1/4", black	25 mm		
	506	F20712	Shrink hose HIS - 3/16", black	65 mm		

## 515 - Cable power supply display - 113638

		<i>Position No.</i>	<i>Part No.</i>	<i>Designation</i>	<i>Quantity</i>	
	500	F20694	Cable ÖZ-0 2 x 0.5 mm <sup>2</sup>	1100 mm		
	501	F27358	Cable end sleeve 0,5 mm <sup>2</sup> white	4 Stk		
	502	F28135-W	Labeling cable W	40 mm		
	503	F28135-1	Labeling cable 1	40 mm		
	504	F28135-6	Labeling cable 6	40 mm		











## 516 - Cable digital inputs - 113639

		<i>Position No.</i>	<i>Part No.</i>	<i>Designation</i>	<i>Quantity</i>	
		500	F28102	Cable ÖZ-J 10x0.5 mm <sup>2</sup>	1300 mm	
		501	F27358	Cable end sleeve 0,5 mm <sup>2</sup> white	10 Stk	
		502	F28135-W	Labeling cable W	40 mm	
		503	F28135-1	Labeling cable 1	40 mm	
		504	F28135-7	Labeling cable 7	40 mm	







## 517 - Cable analog inputs - 113640

		<i>Position No.</i>	<i>Part No.</i>	<i>Designation</i>	<i>Quantity</i>	
	500	F28100	Cable Liycy 2 x 0.5 mm <sup>2</sup>	1200 mm		
	501	F27358	Cable end sleeve 0,5 mm <sup>2</sup> white	4 Stk		
	502	F28135-W	Labeling cable W	40 mm		
	503	F28135-1	Labeling cable 1	40 mm		
	504	F28135-8	Labeling cable 8	40 mm		
	505	F20714	Shrink hose HIS - 1/4", black	25 mm		
	506	F20712	Shrink hose HIS - 3/16", black	65 mm		

## 518 - Cable expansion card - 113641







		<i>Position No.</i>	<i>Part No.</i>	<i>Designation</i>	<i>Quantity</i>	
	500	F20694	Cable ÖZ-0 2 x 0.5 mm <sup>2</sup>	1400 mm		
	501	F27358	Cable end sleeve 0,5 mm <sup>2</sup> white	4 Stk		
	502	F28135-W	Labeling cable W	40 mm		
	503	F28135-1	Labeling cable 1	40 mm		
	504	F28135-9	Labeling cable 9	40 mm		

## 519 - Ground wire - 114083







		<i>Position No.</i>	<i>Part No.</i>	<i>Designation</i>	<i>Quantity</i>	
		500	F27323	Litz 2.5mm <sup>2</sup> H07V-K 2,5 mm <sup>2</sup> GN/YE	230 mm	
		501	F27683	Crimp type socket 630/6, blue isolated	1 Stk	
		502	F27734	Cable end sleeve 2,5 mm <sup>2</sup> blue	1 Stk	



## 520 - Ground wire - 114084

		<i>Position No.</i>	<i>Part No.</i>	<i>Designation</i>	<i>Quantity</i>	
		500	F27323	Litz 2.5mm <sup>2</sup> H07V-K 2,5 mm <sup>2</sup> GN/YE	490 mm	
		501	F27683	Crimp type socket 630/6, blue isolated	1 Stk	
		502	F27734	Cable end sleeve 2,5 mm <sup>2</sup> blue	1 Stk	







## 521 - Ground wire - 114085

		<i>Position No.</i>	<i>Part No.</i>	<i>Designation</i>	<i>Quantity</i>	
		500	F27323	Litz 2.5mm <sup>2</sup> H07V-K 2,5 mm <sup>2</sup> GΠ/YE	1300 mm	
		501	F27683	Crimp type socket 630/6, blue isolated	1 Stk	
		502	F27734	Cable end sleeve 2,5 mm <sup>2</sup> blue	1 Stk	

## 502 - Power supply - 113961











## 502 - Power supply - 113961

		<i>Position No.</i>	<i>Part No.</i>	<i>Designation</i>	<i>Quantity</i>	
		501	114562	Cable gland M 25 x 1,5 / brass	1 Stk	
		502	F29060	Hexagonal nut M 25 x 1,5	1 Stk	
		503	108700	Main switch 32A V3N 05/HS-HF25H-BEH-RG	1 Stk	









## 503 - Additional materials - 113957



## 503 - Additional materials - 113957

		<i>Position No.</i>	<i>Part No.</i>	<i>Designation</i>	<i>Quantity</i>	
		500	115149	Cam switch V2N-A2XHF-X-XX	1 Stk	
		501	113737	dSys Mini IPC Complete device	1 Stk	
		502	F242239	Pressure transmitter DMK 331	1 Stk	
		504	F144363	Spiral hose SP161 9 mm PE TR 25M ME	1 STK	

## 501 - dSys Mini IPC - 113737





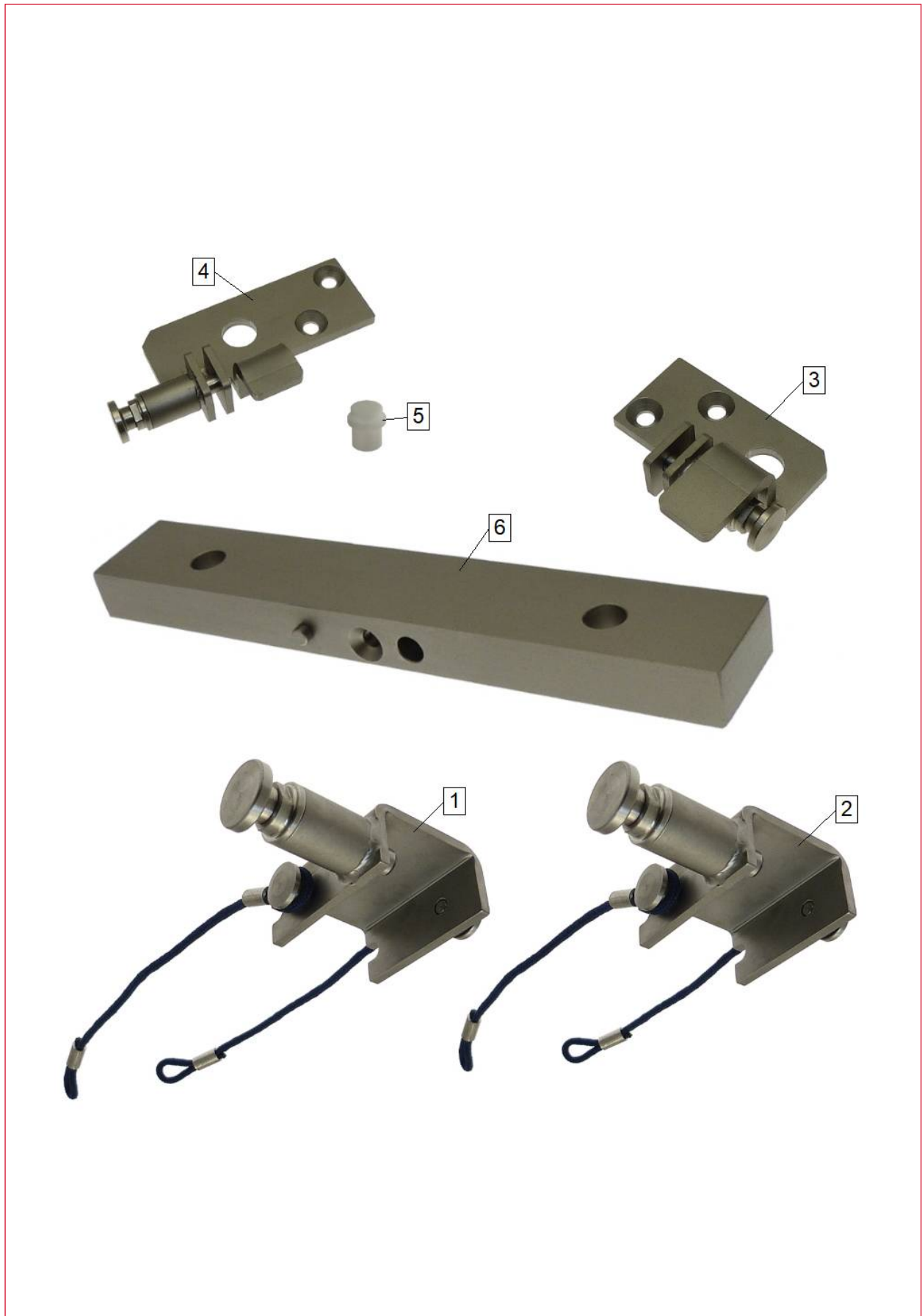







		<i>Position No.</i>	<i>Part No.</i>	<i>Designation</i>	<i>Quantity</i>	
		1	112929	dSys basic device LT4.3	1 Stk	
		2	112930	dSys expansion board MIO 100	1 Stk	
		3	112931	dSys expansion board MIF 100	1 Stk	
		4	114641	Assembly clamp	2 Stk	
		5	114642	Printed-circuit board connecto 8-pin	1 Stk	
		6	114643	Printed-circuit board connecto 2-pin	1 Stk	
		7	114644	Printed-circuit board connecto 2-pin	1 Stk	

## 600 - Suppressor limit (optional) - 115546





## 600 - Suppressor limit (optional) - 115546

		<i>Position No.</i>	<i>Part No.</i>	<i>Designation</i>	<i>Quantity</i>	
		1	114749	Housing Nylon rope 260 mm	1 Stk	
		2	114754	Housing Nylon rope 230 mm	1 Stk	
		3	115545	Housing right	1 Stk	
		4	115539	Housing left	1 Stk	
		5	114762	Bolt d 29 x 33	1 Stk	
		6	115541	Plate IR 29	1 Stk	

# RÜHLE

RÜHLE GmbH  
Beim Signauer Schachen 10  
D-79865 Grafenhausen

Phone: +49 7748-523-11

Fax: +49 7748-523-8511

[info@original-ruehle.de](mailto:info@original-ruehle.de)

[www.original-ruehle.de](http://www.original-ruehle.de)